

EndMill & Face Milling Cutter System

端銑刀及面銑刀系統

J



A001 CJU Drilling & Milling Endmill CJU型鑽銑共用端銑刀

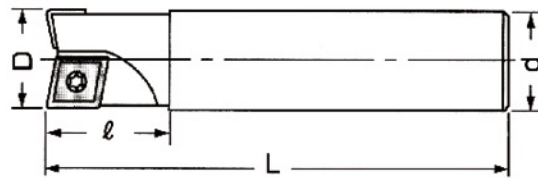

Code NO. 型號	TYPE 規格	D	L	d	ϕ	Teeth 刃數	Insert 刀片規格	Screw 螺絲	Wrench 扳手		
BTSPA0002000	CJU - 1010×130	10	130	10	30	1	CCMT060204	SCR - CJU2.5	T8		
BTSPA0006000	CJU - 1212×130	12	130	12	30	1	CPMT080204Z				
BTSPA0008000	CJU - 1616×120	16	120	16	30	2	CCMT060204 CPMT080204Z				
BTSPA0010000	CJU - 1616×150	16	150	16	40	2					
BTSPA0012000	CJU - 1616×175	16	175	16	40	2					
BTSPA0014000	CJU - 1616×200	16	200	16	40	2					
BTSPA0018000	CJU - 1716×175	17	175	16	40	2	CCMT060204 CPMT090204Z			SCR - CJU2.5 SCR - CJU3.5	T8.T15
BTSPA0020000	CJU - 1716×200	17	200	16	40	2					
BTSPA0022000	CJU - 2020×130	20	130	20	30	2					
BTSPA0024000	CJU - 2020×150	20	150	20	40	2					
BTSPA0026000	CJU - 2020×185	20	185	20	50	2	CPMT090308 CPMT120308Z	SCR - CJU4	T15		
BTSPA0030000	CJU - 2120×150	21	150	20	40	2					
BTSPA0032000	CJU - 2120×200	21	200	20	40	2					
BTSPA0034000	CJU - 2525×130	25	130	25	40	2					
BTSPA0036000	CJU - 2525×150	25	150	25	50	2	CPMT120408 CPMT160408Z	SCR - CJU5	T20		
BTSPA0038000	CJU - 2525×220	25	220	25	70	2					
BTSPA0042000	CJU - 2625×200	26	200	25	50	2					
BTSPA0044000	CJU - 2625×250	26	250	25	50	2					
BTSPA0046000	CJU - 3232×170	32	170	32	50	2	CPMT120408 CPMT160408Z	SCR - CJU5	T20		
BTSPA0048000	CJU - 3232×250	32	250	32	80	2					
BTSPA0050000	CJU - 3232×300	32	300	32	80	2					
BTSPA0052000	CJU - 3332×350	32	350	32	80	2					

* Hitachi inserts recommended
* 建議使用 Hitach 銑刀片

A003 EHU High-Speed Endmill

EHU型超快削型端銑刀

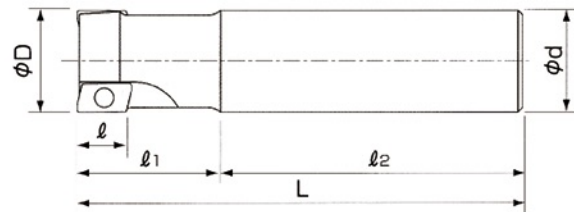

Code NO. 型號	TYPE 規格	φD	φd	f	f1	f2	L	Teeth 刃數	Insert 刀片規格	Screw 螺絲	Wrench 扳手
BTSPA0144000	EHU10 - 1616 × 150	16	16	10	50	100	150	2	JDMT1003	SCR - EHU2.5	T7
BTSPA0146000	EHU10 - 2020 × 130	20	20	10	30	100	130	3			
BTSPA0148000	EHU10 - 2020 × 150	20	20	10	50	100	150	3			
BTSPA0150000	EHU10 - 2525 × 150	25	25	10	40	110	150	4			
BTSPA0152000	EHU10 - 2525 × 200	25	25	10	60	140	200	4			
BTSPA0162000	EHU15 - 2525 × 150	25	25	15	40	110	150	2	JDMT1505	SCR - EHU4	T15
BTSPA0164000	EHU15 - 2525 × 200	25	25	15	60	140	200	2			
BTSPA0166000	EHU15 - 3025 × 150	30	25	15	40	110	150	2			
BTSPA0168000	EHU15 - 3025 × 200	30	25	15	40	160	200	2			
BTSPA0170000	EHU15 - 3232 × 150	32	32	15	40	110	150	3			
BTSPA0172000	EHU15 - 3232 × 200	32	32	15	60	140	200	3			
BTSPA0174000	EHU15 - 3532 × 150	35	32	15	40	110	150	3			
BTSPA0176000	EHU15 - 3532 × 200	35	32	15	60	140	200	3			

* Hitachi inserts recommended
* 建議使用 Hitachi 銑刀片

A004 EHJ Drilling & Milling Endmill EHJ型多功能快削型銑刀

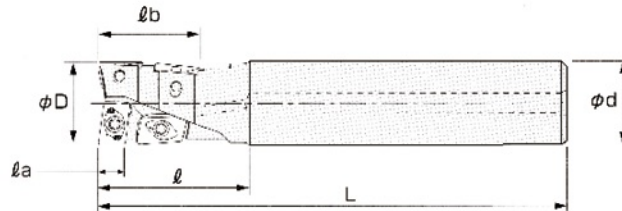

Code NO. 型號	TYPE 規格	ϕD	L	ℓa	ℓb	ℓ	ϕd	Insert 刀片規格	Pcs 數量	Insert 刀片規格	Pcs 數量	Wrench 扳手
BTSPA0202000	EHJ2 - 1616 × 120	16	120	4.5	8.5	33	16	J D M T 080308L	1	J D M T 090308R	1	T6
BTSPA0204000	EHJ2 - 1616 × 175	16	175	4.5	8.5	50	16					
BTSPA0206000	EHJ2 - 1716 × 120	17	120	4.5	8.5	33	16					
BTSPA0208000	EHJ2 - 1716 × 175	17	175	4.5	8.5	33	16					
BTSPA0210000	EHJ2 - 2020 × 130	20	130	5.5	9.5	35	20	J D M T 100308L	1	J D M T 100308R	1	T7
BTSPA0212000	EHJ2 - 2020 × 185	20	185	5.5	9.5	60	20					
BTSPA0214000	EHJ2 - 2120 × 130	21	130	5.5	9.5	35	20					
BTSPA0216000	EHJ2 - 2120 × 185	21	185	5.5	9.5	35	20					
BTSPA0218000	EHJ2 - 2525 × 140	25	140	7	12.5	45	25	J D M T 12T308L	1	J D M T 12T308R	1	T10
BTSPA0220000	EHJ2 - 2525 × 220	25	220	7	12.5	75	25					
BTSPA0226000	EHJ2 - 3232 × 150	32	150	8.5	14.5	50	32	J D M T 160508L	1	J D M T 150508R	1	T15
BTSPA0228000	EHJ2 - 3232 × 230	32	230	8.5	14.5	90	32					

*Hitachi inserts recommended
*建議使用 Hitach 銑刀片

A005 ESRF High-Feed Milling Cutter

ESRF型高效率切削平面銑刀

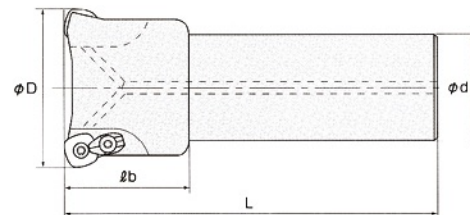
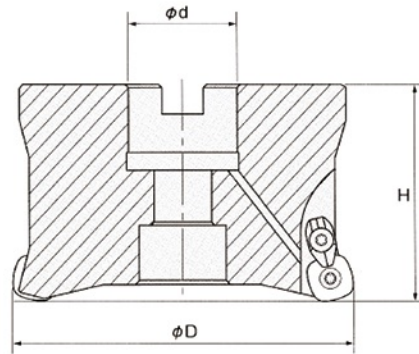

Code NO. 型號	TYPE 規格	ϕD	L	ϕd	l_b	Teeth 刃數	Insert 刀片規格	Wrench 扳手
BTSPA0294000	ESRF - 3232 x 200	32	200	32	70	2	SDNW1205ZDTN-R15 SDNT1205ZDTN-R15	T15
BTSPA0296000	ESRF - 3232 x 250	32	250	32	70	2		
BTSPA0298000	ESRF - 4032 x 200	40	200	32	70	3		
BTSPA0300000	ESRF - 4032 x 250	40	250	32	70	3		
BTSPA0302000	ESRF - 4032 x 300	40	300	32	70	3		

* Hitachi inserts recommended
* 建議使用 Hitachi 銑刀片

A006 CEX High-Speed Endmill

CEX型快削型端銑刀

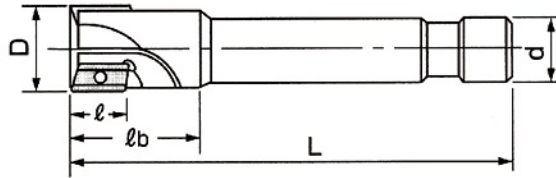

Code NO. 型號	TYPE 規格	D	L	d	r_1	r_2	ϕd	Insert 刀片規格	Screw 螺絲	Wrench 扳手
BTSPA0324000	CEX - 1212 × 150	12	150	12	12	25	1	APET1202	SCR - CEX5	T15
BTSPA0326000	CEX - 1616 × 120	16	120	16	12	30	1			
BTSPA0328000	CEX - 1616 × 150	16	150	16	12	30	1			
BTSPA0332000	CEX - 2020 × 120	20	120	20	12	30	2			
BTSPA0334000	CEX - 2020 × 150	20	150	20	12	30	2			
BTSPA0336000	CEX - 2020 × 200	20	200	20	12	30	2			
BTSPA0338000	CEX - 2525 × 130	25	130	25	15	35	2	ADET1603	SCR - CEX4	
BTSPA0340000	CEX - 2525 × 160	25	160	25	15	35	2			
BTSPA0342000	CEX - 2525 × 200	25	200	25	15	35	2			
BTSPA0344000	CEX - 2525 × 250	25	250	25	15	35	2			
BTSPA0346000	CEX - 3025 × 150	30	150	25	15	45	2			
BTSPA0350000	CEX - 3232 × 150	32	150	32	15	45	3			

*Hitachi inserts recommended * 建議使用 Hitach 銑刀片

A007 CAP300R High-Speed Rough Endmill

CAP300R型快削型端銑刀

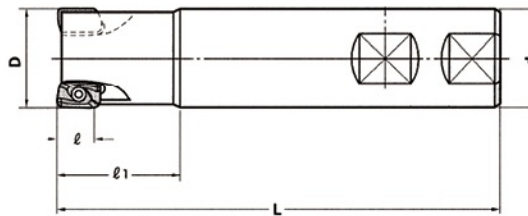

Code NO. 型號	TYPE 規格	D	d	r_1	r_2	L	Teeth 刀數	Insert 刀片規格	Screw 螺絲	Wrench 扳手
BTSPA0382000	CAP300R - 1010 × 100	10	10	25	9	100	1	APMT 1135PDER	SCR - CAP2.5	T8
BTSPA0384000	CAP300R - 1016 × 100	10	16	25	9	100	1			
BTSPA0386000	CAP300R - 1212 × 100	12	12	25	9	100	1			
BTSPA0388000	CAP300R - 1216 × 100	12	16	25	9	100	1			
BTSPA0390000	CAP300R - 1616 × 120	16	16	25	9	120	2			
BTSPA0392000	CAP300R - 1616 × 160	16	16	25	9	160	2			
BTSPA0394000	CAP300R - 2020 × 120	20	20	30	9	120	2			
BTSPA0396000	CAP300R - 2020 × 150	20	20	30	9	150	2			
BTSPA0398000	CAP300R - 2020 × 200	20	20	30	9	200	2			
BTSPA0400000	CAP300R - 2525 × 150	25	25	35	9	150	4			
BTSPA0402000	CAP300R - 2525 × 200	25	25	35	9	200	4			

*Mitsubishi inserts recommended * 建議使用 Mitsubishi 銑刀片

A008 CAP400R High-Speed Rough Endmill

CAP400R型快削型端銑刀

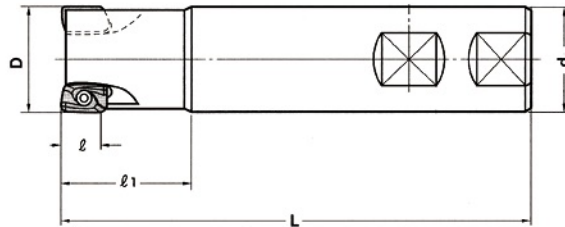

Code NO. 型號	TYPE 規格	D	d	r1	r2	L	Teeth 刃數	Insert 刀片規格	Screw 螺絲	Wrench 扳手
BTSPA0422000	CAP400R - 2525 × 150	25	25	35	14	150	2	APMT 1604PDER	SCR - CAP4	T15
BTSPA0424000	CAP400R - 2525 × 200	25	25	35	14	200	2			
BTSPA0426000	CAP400R - 3025 × 150	30	25	45	14	150	2			
BTSPA0428000	CAP400R - 3025 × 200	30	25	45	14	200	2			
BTSPA0430000	CAP400R - 3232 × 150	32	32	45	14	150	3			
BTSPA0432000	CAP400R - 3232 × 200	32	32	60	14	200	3			
BTSPA0434000	CAP400R - 3232 × 250	32	32	60	14	250	3			
BTSPA0436000	CAP400R - 3232 × 300	32	32	60	14	300	3			
BTSPA0440000	CAP400R - 3532 × 150	35	32	45	14	150	3			
BTSPA0442000	CAP400R - 3532 × 200	35	32	45	14	200	3			
BTSPA0444000	CAP400R - 3532 × 250	35	32	45	14	250	3			
BTSPA0446000	CAP400R - 3532 × 300	35	32	45	14	300	3			
BTSPA0452000	CAP400R - 4032 × 150	40	32	45	14	150	3			
BTSPA0454000	CAP400R - 4032 × 200	40	32	45	14	200	3			
BTSPA0456000	CAP400R - 5032 × 150	50	32	45	14	150	4			
BTSPA0458000	CAP400R - 5042 × 150	50	42	45	14	150	4			

* Mitsubishi inserts recommended
* 建議使用 Mitsubishi 銑刀片

A009 CAP400R Face Milling Cutter CAP400R型平面銑刀

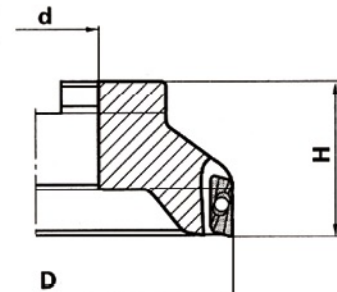
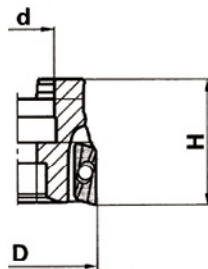

Code NO. 型號	TYPE 規格	D	d	H	Teeth 刃數	Insert 刀片規格	Screw 螺絲	Wrench 扳手
BTSPA0473000	CAP400R - FM50	50	22	40	4	APMT 1604	SCR - CAP4	T15
BTSPA0474000	CAP400R - FM63	63	25.4	40	5			
BTSPA0475000	CAP400R - FM63	63	22	40	5			
BTSPA0476000	CAP400R - FM80	80	25.4	50	6			
BTSPA0477000	CAP400R - FM80	80	27	50	6			
BTSPA0478000	CAP400R - FM100	100	31.75	50	7			
BTSPA0479000	CAP400R - FM100	100	32	50	7			
BTSPA0480000	CAP400R - FM125	125	38.1	50	8			
BTSPA0481000	CAP400R - FM125	125	40	50	8			
BTSPA0482000	CAP400R - FM160	160	38.1	50	10			
BTSPA0483000	CAP400R - FM160	160	40	50	10			

**Mitsubishi inserts recommended * 建議使用 Mitsubishi 銑刀片

A010 SFM Shoulder Face Milling Cutter SFM型直角平面銑刀

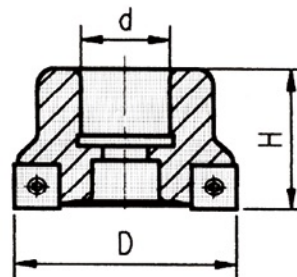

Code NO. 型號	TYPE 規格	D	d	H	Teeth 刃數	Insert 刀片規格	Screw 螺絲	Wrench 扳手
BTSPA0504000	SFM - 63	63	25.4	40	5	SPLT1204	SCR - SFM5	T20
BTSPA0506000	SFM - 80	80	25.4	45	6			
BTSPA0508000	SFM - 100	100	31.75	50	7			

* ISO code * 符合 ISO 規範

A013 CRS Radius Endmill

CRS型R角端銑刀

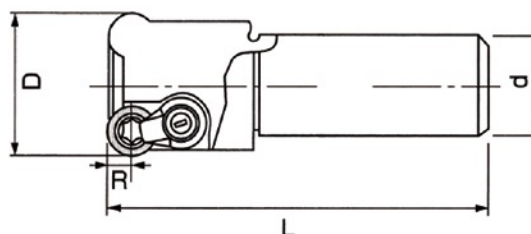

Code NO. 型號	TYPE 規格	D	L	d	R	Teeth 刃數	Insert 刀片規格	Clamp 壓板	Screw 螺絲	Wrench 扳手
BTSPA0594000	CRS - 4R12 × 150	12	150	12	4	1	RDMT0802	CL - 4R	SCR- CRS3	T10/15
BTSPA0596000	CRS - 4R16 × 120	16	120	16	4	1/2				
BTSPA0598000	CRS - 4R16 × 150	16	150	16	4	2				
BTSPA0600000	CRS - 4R20 × 150	20	150	20	4	2				
BTSPA0602000	CRS - 4R20 × 200	20	200	20	4	2	RDMT10T3	CL - 5R	SCR- CRS3.5	T15
BTSPA0604000	CRS - 5R25 × 150	25	150	25	5	2				
BTSPA0606000	CRS - 5R25 × 200	25	200	25	5	2				
BTSPA0608000	CRS - 5R25 × 250	25	250	25	5	2				
BTSPA0610000	CRS - 5R25 × 300	25	300	25	5	2				
BTSPA0612000	CRS - 5R30 × 150	30	150	25	5	2				
BTSPA0614000	CRS - 5R30 × 200	30	200	25	5	2				
BTSPA0616000	CRS - 5R30 × 250	30	250	25	5	2				
BTSPA0620000	CRS - 5R32 × 150	32	150	32	5	3				
BTSPA0622000	CRS - 5R32 × 200	32	200	32	5	3				
BTSPA0624000	CRS - 5R32 × 250	32	250	32	5	3				
BTSPA0628000	CRS - 5R35 × 150	35	150	32	5	3				
BTSPA0630000	CRS - 5R35 × 200	35	200	32	5	3				
BTSPA0632000	CRS - 5R35 × 250	35	250	32	5	3				
BTSPA0634000	CRS - 5R35 × 300	35	300	32	5	3				
BTSPA0638000	CRS - 5R40 × 150	40	150	32	5	3				
BTSPA0640000	CRS - 5R40 × 200	40	200	32	5	3				

* Hitachi inserts recommended
* 建議使用 Hitach 銑刀片

A014 CRP Radius Endmill CRP型R角端銑刀

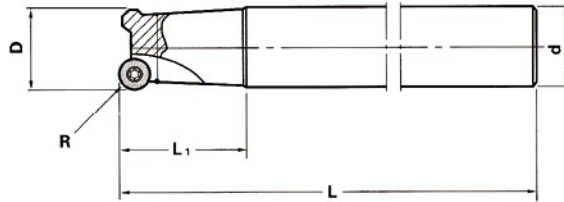

Code NO. 型號	TYPE 規格	D	R	L	L1	d	Teeth 刀數	Insert 刀片規格	Screw 螺絲	Wrench 扳手
BTSPA0670000	CRP - 5R25 × 200	25	5	200	60	25	2	RPMW-1003MO	SCR - CRP4 SCR-W3/16S	T15
BTSPA0676000	CRP - 5R30 × 150	30	5	150	45	25	2			
BTSPA0678000	CRP - 5R30 × 200	30	5	200	45	25	2			
BTSPA0680000	CRP - 5R30 × 250	30	5	250	45	25	2			
BTSPA0682000	CRP - 5R30 × 300	30	5	300	45	25	2			
BTSPA0684000	CRP - 5R35 × 150	35	5	150	45	32	3			
BTSPA0686000	CRP - 5R35 × 200	35	5	200	45	32	3			
BTSPA0688000	CRP - 5R35 × 250	35	5	250	45	32	3			
BTSPA0690000	CRP - 5R35 × 300	35	5	300	45	32	3			
BTSPA0692000	CRP - 5R40 × 150	40	5	150	45	32	3			
BTSPA0694000	CRP - 5R40 × 200	40	5	200	45	32	3	RPMW-1203MO	SCR - CRP4L SCR - W3 / 16S	T15
BTSPA0698000	CRP - 6R35 × 150	35	6	150	45	32	3			
BTSPA0700000	CRP - 6R35 × 200	35	6	200	45	32	3			
BTSPA0702000	CRP - 6R35 × 250	35	6	250	45	32	3			
BTSPA0704000	CRP - 6R40 × 150	40	6	150	45	32	3			
BTSPA0706000	CRP - 6R40 × 200	40	6	200	45	32	3			

*Mitsubishi inserts recommended
*建議使用 Mitsubishi 銑刀片

A015 CRT Radius Endmill

CRT型R角端銑刀

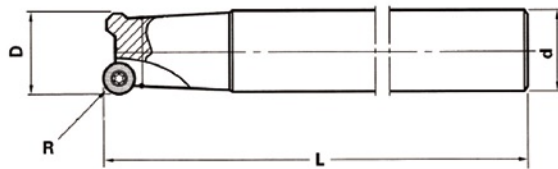

Code NO. 型號	TYPE 規格	D	d	R	L	Teeth 刃數	Insert 刀片規格	Screw 螺絲	Wrench 扳手
BTSPA0732000	CRT - 6R32 × 150	32	32	6	150	2	RPMT 1204MO	SCR - CRT4	T15
BTSPA0734000	CRT - 6R32 × 200	32	32	6	200	2			
BTSPA0738000	CRT - 6R35 × 150	35	32	6	150	3			
BTSPA0740000	CRT - 6R35 × 200	35	32	6	200	3			
BTSPA0746000	CRT - 6R40 × 150	40	32	6	150	3			
BTSPA0748000	CRT - 6R40 × 200	40	32	6	200	3			
BTSPA0752000	CRT - 6R50 × 150	50	32	6	150	4			
BTSPA0754000	CRT - 6R50 × 200	50	32	6	200	4			

*Mitsubishi inserts recommended
*建議使用 Mitsubishi 銑刀片

A016 CRS Radius Face Milling Cutter

CRS型R角平面銑刀

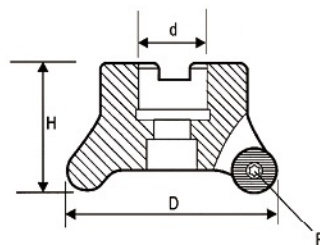

Code NO. 型號	TYPE 規格	D	d	H	R	Teeth 刀數	Insert 刀片規格	Screw 螺絲	Clamp 壓板	Wrench 扳手
BTSPA0782000	CRS - 5R50	50	25.4	45	5	4	RDMT10T3	SCR-CRS4	CL-5R	T15
BTSPA0783000	CRS - 5R50		22							
BTSPA0784000	CRS - 5R63	63	25.4	50	5					
BTSPA0785000	CRS - 5R63		22							
BTSPA0787000	CRS - 8R50	50	22	45	8	3			-	
BTSPA0788000	CRS - 8R63		25.4							
BTSPA0789000	CRS - 8R63	63	22	50	8	3/4			CL-8R	
BTSPA0790000	CRS - 8R66		25.4							
BTSPA0791000	CRS - 8R66	66	22	50	8	4				
BTSPA0792000	CRS - 8R80		25.4							
BTSPA0793000	CRS - 8R80	80	27	50	8	5	RDMT1604	SCR-CRS5	-	T20
BTSPA0794000	CRS - 8R100		31.75							
BTSPA0795000	CRS - 8R100	100	32	55	8	5			CL-8R116H	
BTSPA0796000	CRS - 8R116		31.75							
BTSPA0797000	CRS - 8R116	116	32	60	8	6			-	

*Mitsubishi inserts recommended
*建議使用 Mitsubishi 銑刀片

A017 CRP Radius Face Milling Cutter

CRP型R角平面銑刀

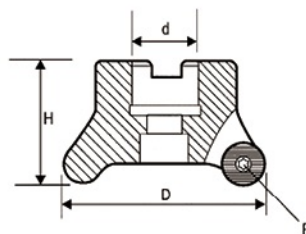

Code NO. 型號	TYPE 規格	D	d	H	R	Teeth 刀數	Insert 刀片規格	Screw 螺絲	Wrench 扳手
BTSPA0823000	CRP - 5R50	50	22	45	5	4	R P M W	SCR - CRP4	T15
BTSPA0824000	CRP - 5R63	63	25.4	50		5	1003MO	SCR - W3 / 16S	
BTSPA0826000	CRP - 6R50	50	-	45	6	4	R P M W	SCR - CRP4L	T15
BTSPA0828000	CRP - 6R63	63	25.4	50		5	1203MO	SCR - W3 / 16S	

*Mitsubishi inserts recommended
*建議使用 Mitsubishi 銑刀片

A018 CRT Radius Face Milling Cutter

CRT型R角平面銑刀

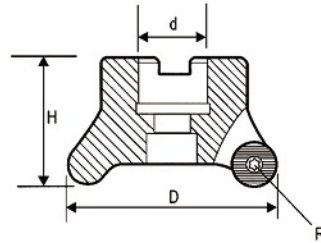

Code NO. 型號	TYPE 規格	D	d	H	R	Teeth 刀數	Insert 刀片規格	Screw 螺絲	Wrench 扳手
BTSPA0853000	CRT - 6R50	50	22	45	6	4	R P M T 1204MO	SCR-CRT4 SCR-CRT3.5	T15
BTSPA0854000	CRT - 6R63	63	25.4	50					
BTSPA0855000	CRT - 6R63		22						
BTSPA0856000	CRT - 6R80	80	25.4	50					
BTSPA0857000	CRT - 6R80		27						
BTSPA0858000	CRT - 6R100	100	31.75	55					
BTSPA0859000	CRT - 6R100		32						

* Mitsubishi inserts recommended
* 建議使用 Mitsubishi 銑刀片

A020 C2139 Ball-Nose Endmill

C2139球型端銑刀

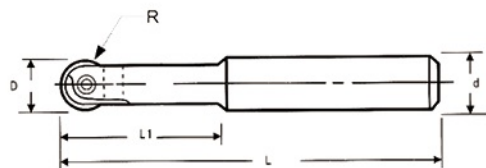

Code NO. 型號	TYPE 規格	R	D	d	L	L1	Insert 刀片規格	Screw 螺絲	Wrench 扳手
BTSPA0922000	C2139 - 4R8 × 130	4	8	8	130	30	P3200D08	SCR - CR4i	T8
BTSPA0924000	C2139 - 5R10 × 130	5	10	10	130	30	P3200D10	SCR - CR5i	T15
BTSPA0926000	C2139 - 5R12 × 130	5	10	12	130	30			
BTSPA0928000	C2139 - 6R12 × 130	6	12	12	130	32	P3200D12	SCR - CR6i	T20
BTSPA0930000	C2139 - 8R16 × 150	8	16	16	150	36	P3200D16	SCR - CR8i	
BTSPA0932000	C2139 - 10R20 × 160	10	20	20	160	45	P3200D20	SCR - CR10i	
BTSPA0934000	C2139 - 10R20 × 200	10	20	20	200	45			
BTSPA0936000	C2139 - 12.5R25 × 180	12.5	25	25	180	45	P3200D25	SCR - CR 12.5i	T30

* Walter inserts recommended
* 建議使用 Walter 銑刀片

A021 C2139 Ball-Nose Endmill C2139加長球型端銑刀

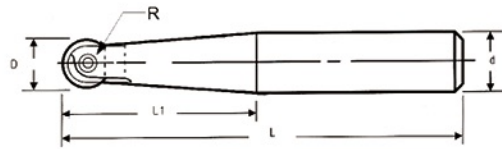

Code NO. 型號	TYPE 規格	R	D	d	L	L1	Insert 刀片規格	Screw 螺絲	Wrench 扳手
BTSPA0962000	C2139 - 4R12 × 140	4	8	12	140	45	P3200D08	SCR - CR4i	T8
BTSPA0964000	C2139 - 5R12 × 150	5	10	12	159	35	P3200D10	SCR - CR5i	T15
BTSPA0966000	C2139 - 6R16 × 160	6	12	16	160	58	P3200D12	SCR - CR6i	T20
BTSPA0968000	C2139 - 8R20 × 200	8	16	20	200	65	P3200D16	SCR - CR8i	

*Walter inserts recommended
*建議使用Walter 銑刀片

A022 CBP Ball-Nose Endmill CBP球型端銑刀

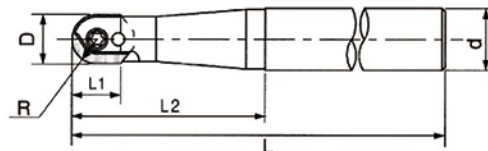

Code NO. 型號	TYPE 規格	R	D	d	L	L1	L2	Insert 刀片規格	Screw(Front) 前螺絲	Screw(Rear) 後螺絲	Wrench 扳手
BTSPA1004000	CBP - 8R20 × 130	8	16	20	130	13	50	ZPFW160	SCR - AR8	SCR - CBP3.5	T15

*Hitachi inserts recommended
*建議使用Hitachi 銑刀片

A023 TB Twin- Blade Boring Bar

TB固定式雙刃粗搪刀桿

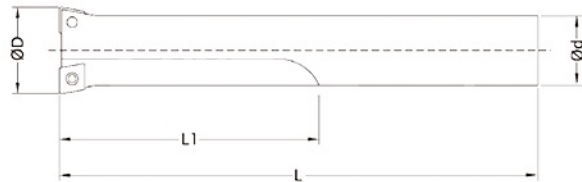

Code NO. 型號	TYPE 規格	D	d	L1	L	Insert 刀片規格	Screw 螺絲	Wrench 扳手
BTSPA1046000	TB - 1616.100	15.7	16	50	100	CCMT09T308	SCR - TB4	T8
BTSPA1054000	TB - 2016.110	19.7	16	60	110			
BTSPA1056000	TB - 2016.150	19.7	16	60	150			
BTSPA1060000	TB - 2316.110	22.7	16	60	110			
BTSPA1062000	TB - 2420.120	23.7	20	70	120			
BTSPA1064000	TB - 2520.120	24.7	20	70	120			
BTSPA1068000	TB - 3025.160	29.7	25	90	160	CCMT09T308	SCR - TB4	T15
BTSPA1070000	TB - 3025.190	29.7	25	90	190			
BTSPA1072000	TB - 3525.160	34.7	25	90	160			
BTSPA1074000	TB - 3532.230	34.7	32	90	230			
BTSPA1076000	TB - 4025.160	39.7	25	90	160			
BTSPA1078000	TB - 4035.250	39.7	35	90	250			

* ISO Code
* 符合 ISO 規範

A024 XEM High Efficiency Rough Endmill

XEM高效率快削型端銑刀

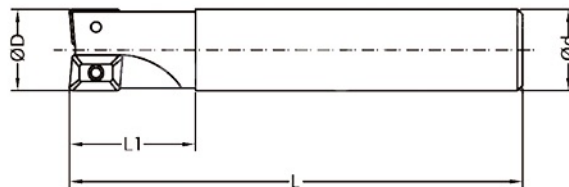

Code NO. 型號	TYPE 規格	ØD	Ød	L1	L	Teeth 刀數	Insert 刀片規格	Screw 螺絲	Wrench 扳手
BTSPA1103000	XEM10 - 1010.100	10	10	20	100	1	APMT1035	SCR - XEM2.5	T8
BTSPA1104000	XEM10 - 1212.100	12	12	25	100	1			
BTSPA1108000	XEM10 - 1616.100	16	16	25	100	2			
BTSPA1112000	XEM10 - 2020.110	20	20	30	110	3			
BTSPA1114000	XEM10 - 2020.150	20	20	50	150	3			
BTSPA1118000	XEM10 - 2525.150	25	25	60	150	4	APMT1605	SCR - XEM4	T15
BTSPA1122000	XEM16 - 2525.150	25	25	60	150	2			

* Nachi or Sumitomo inserts recommended
* 建議使用 Nachi 或 Sumitomo 銑刀片

RGH Shell-Type Rough Milling Cutter

RGH粗重切削筒狀銑刀

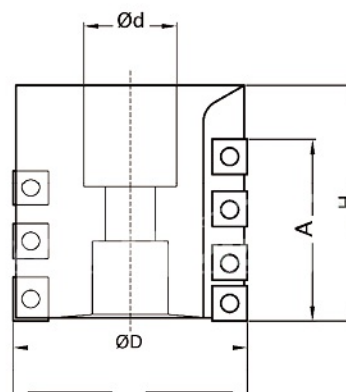

Code NO. 型號	TYPE 規格	ØD	A	H	Ød	Flute 槽數	Insert 刀片規格	Pcs 數量	Insert 刀片規格	Pcs 數量	Screw 螺絲	Wrench 扳手
BTSPA1152000	RGH - 80 × 31.75	80	67	80	31.75	6	LPMT - 1504	3	SPMT-1204	18	SCR - RGH5	T20
BTSPA1154000	RGH - 80 × 32	80	67	80	32							

* Walter inserts recommended
* 建議使用 Walter 銑刀片

A026 RGH BT50 Rough Milling Cutter

RGH BT50一體式粗重銑刀

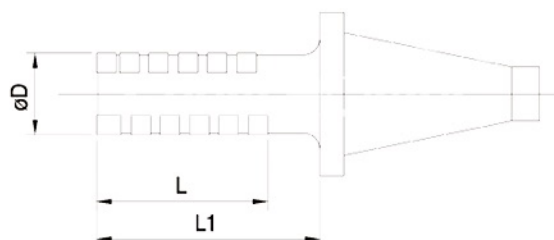

Code NO. 型號	TYPE 規格	øD	L	L1	Flute 槽數	Insert 刀片規格	Pcs 數量	Insert 刀片規格	Pcs 數量
BTSPA1172000	BT50 - RGH50.77	50	77	H7	4	LPMT 1504	2	SPMT 1204	14
BTSPA1174000	BT50 - RGH50.97	50	97	137					18
BTSPA1176000	BT50 - RGH50.127	50	127	167					24
BTSPA1178000	BT50 - RGH50.157	50	157	197					30
BTSPA1182000	BT50 - RGH63.87	63	87	127					16
BTSPA1184000	BT50 - RGH63.107	63	107	147					20
BTSPA1186000	BT50 - RGH63.157	63	157	197					30
BTSPA1188000	BT50 - RGH80.107	80	107	147	6	3		30	

Screw 螺絲	Wrench 扳手
SCR - RGH5	T20

* Walter inserts recommended
* 建議使用 Walter 銑刀片

A027 RGH Rough Milling Cutter

RGH粗切削端銑刀

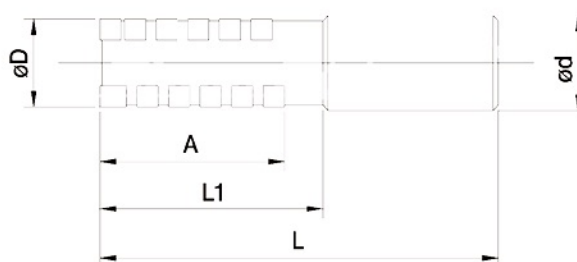

Code NO. 型號	TYPE 規格	øD	ød	A	L1	L	Flute 槽數	Insert 刀片規格	Pcs 數量	Insert 刀片規格	Pcs 數量	Screw 螺絲	Wrench 扳手
BTSPA1236000	RGH - 3242 × 150	32	32	42	70	150	2	LPMT	1	SDNT	5	SCR - RGH4	T15
BTSPA1238000	RGH - 4050 × 155	40	32	50	75	155	4	15T308	2	090308	12		
BTSPA1242000	RGH - 5077 × 205	50	50.8	77	115	205	4		2		14		
BTSPA1244000	RGH - 5097 × 225	50	50.8	97	135	225	4	LPMT	2	SPMT	18	SCR - RGH5	T20
BTSPA1246000	RGH - 50127 × 225	50	50.8	127	165	255	4	1504	2	1204	24		
BTSPA1248000	RGH - 50157 × 285	50	50.8	157	195	285	4		2		30		

* Walter inserts recommended
* 建議使用 Walter 銑刀片

A029 ESR High Efficiency Endmill

ESR高進給切削端銑刀

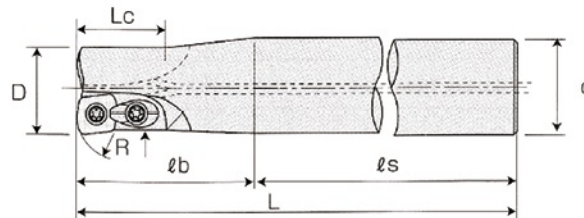

Code NO. 型號	TYPE 規格	D	L	R	rb	rs	Lc	d	Teeth 刃數	Insert 刀片規格	Screw 螺絲	Clamp 壓板	Wrench 扳手
BTSPA1302000	ESR - 2020 × 130	20	130	10	50	80	20	20	2	E P N W 0803TN - 10	SCR - ESR3.5	CL - ESR3.5	T15
BTSPA1310000	ESR - 2525 × 200	25	200	10	120	80	25	25	2	E P N W 10T3TN - 10	SCR - ESR4		
BTSPA1322000	ESR - 3232 × 200	32	200	15	120	80	29	32	2	E D N W 13T4TN - 15 E D N W 13T4TN - 10	SCR - ESR5	CL - ESR5	T20
BTSPA1324000	ESR - 3232 × 300	32	300	15	180	120	29	32	2				
BTSPA1326000	ESR - 3532 × 150	35	150	15	50	100	-	32	2				
BTSPA1328000	ESR - 3532 × 200	35	200	15	50	150	-	32	2				
BTSPA1330000	ESR - 3532 × 250	35	250	15	50	200	-	32	2				

* Hitachi inserts recommended
* 建議使用 Hitach 銑刀片

A030 ESR High Efficiency Milling Endmill

ESR高進給切削平面銑刀

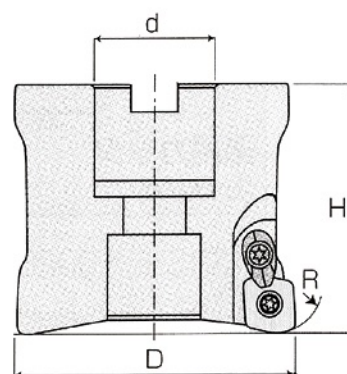

Code NO. 型號	TYPE 規格	D	H	R	d	Teeth 刃數	Insert 刀片規格	Screw 螺絲	Clamp 壓板	Wrench 扳手
BTSPA1364000	ESR - 63	63	50	15(10)	25.4	4	EDNW15T4TN - 15 EDNW15T4TN - 10	SCR - ESR5	CL - ESR5	T20
BTSPA1366000	ESR - 66	66	50	15(10)	25.4	4				
BTSPA1368000	ESR - 80	80	70	15(10)	25.4	5				

* Hitachi inserts recommended
* 建議使用 Hitach 銑刀片

A031 TCM 45° Chamfering Endmill

TCM 45°倒角刀

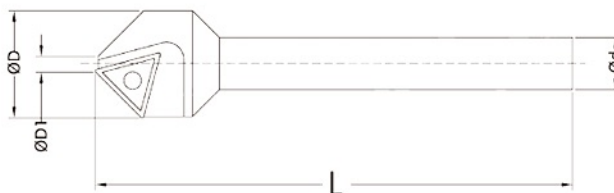

Code NO. 型號	TYPE 規格	ØD	ØD1	Ød	L	Insert 刀片規格	Screw 螺絲	Wrench 扳手
BTSPA1392000	TCM - 03 - 25	25	3	12	110	TCMT16T304	SCR - TCM4	T15

* ISO Code * 符合 ISO 規範

A032 CM 45° Chamfering Endmill

CM 45°倒角刀

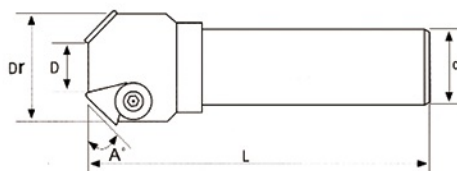

Code NO. 型號	TYPE 規格	A°	D	Dr	d	L	Teeth 刃數	Insert 刀片規格	Screw 螺絲	Wrench 扳手
BTSPA1402000	CM45 - 0521 × 16	45	5	21	16	120	1	TPUN1603	SCR - W1 / 4	WRN - M4L
BTSPA1404000	CM45 - 1031 × 20	45	10	31	20	120	2			
BTSPA1406000	CM45 - 2050 × 25	45	20	50	25	130	3	TPUN2204	SCR - W5 / 16	WRN - M5L
BTSPA1408000	CM45 - 0632 × 32	45	6	32	32	150	1			
BTSPA1410000	CM45 - 2050 × 32	45	20	50	32	150	3			
BTSPA1412000	CM45 - 3563 × 25	45	35	63	25	150	3			
BTSPA1414000	CM45 - 3563 × 32	45	35	63	32	150	3			

* ISO Code * 符合 ISO 規範

A033 CH Bolt Countersink Endmill

CH 螺絲頭沉孔銑刀

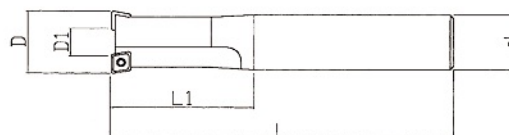

Code NO. 型號	TYPE 規格	D	L	L1	D1	d	Teeth 刃數	Insert 刀片規格	Screw 螺絲	Wrench 扳手
BTSPA1432000	CH - 8 - 14 - 25	14	108	21	2.9	25	1	C C M T 060204	SCR - CJU2.5	T8
BTSPA1434000	CH - 10 - 17.5 - 25	17.5	115	26	5.3	25	2			
BTSPA1436000	CH - 12 - 20 - 25	20	120	30	7.8	25	2			
BTSPA1438000	CH - 14 - 23 - 25	23	126	34.5	10.8	25	2	C P M T 090308	SCR - CH4	T15
BTSPA1440000	CH - 16 - 26 - 32	26	132	39	8.5	32	2			
BTSPA1442000	CH - 18 - 29 - 32	29	138	43.5	11.5	32	2			
BTSPA1444000	CH - 20 - 32 - 32	32	144	59	14.5	32	2			

* Hitachi inserts recommended * ISO Code * 建議使用 Hitach 銑刀片 * 符合 ISO 規範

A034 TS T-Slot Endmill

TS T型槽端銑刀

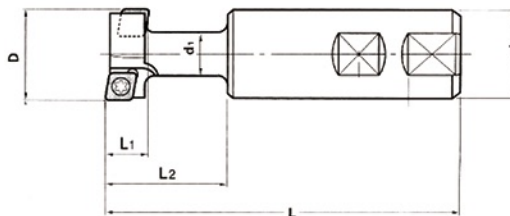

Code NO. 型號	TYPE 規格	D	L1	d	d1	L2	L	Teeth 刃數	Insert 刀片規格	Screw 螺絲	Wrench 扳手
BTSPA1462000	TS - 24 - 11 - 20	24	11	20	12	29	90	4	CCMT - 060204	SCR - TS2.5	T8
BTSPA1464000	TS - 31 - 14 - 25	31	14	25	15	42	110	4	CPMT - 080204Z		
BTSPA1466000	TS - 39 - 18 - 32	39	18	32	19	49	120	4	CPMT - 090308	SCR - TS4	T15
BTSPA1468000	TS - 49 - 22 - 32	49	22	32	25	60	140	4	CPMT - 120408	SCR - TS5	T20

* ISO Code
* 符合 ISO 規範

A035 SE45° High-Speed Face Milling Cutter

SE45° 高速平面殼型銑刀

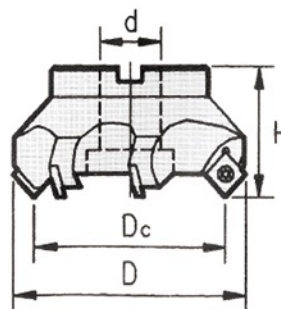

Code NO. 型號	TYPE 規格	Dc	D	d	H	Teeth 刃數	Insert 刀片規格	Screw 螺絲	Wrench 扳手
BTSPA1493000	SE - 50	50	60	22	45	4	SEKT1204	SCR - SE5	T20
BTSPA1494000	SE - 63	63	75	25.4	50	5			
BTSPA1495000	SE - 63	63	75	27	50	5			
BTSPA1496000	SE - 80	80	96	25.4	55	6			
BTSPA1497000	SE - 80	80	96	27	55	6			
BTSPA1498000	SE - 100	100	116	31.75	55	6			
BTSPA1499000	SE - 100	100	116	32	55	6			
BTSPA1500000	SE - 125	125	141	38.1	60	8			
BTSPA1501000	SE - 125	125	141	40	60	8			
BTSPA1502000	SE - 150	150	158	50.8	60	10			
BTSPA1503000	SE - 150	150	158	40	60	10			
BTSPA1504000	SE - 200	200	212	47.625	60	12			

* Metric* ISO Code
* 公制 * 符合 ISO 規範

A036 SE 45° High-Speed Face Milling Cutter

SE 45°高速殼型銑刀

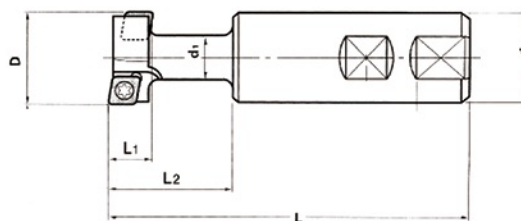

Code NO. 型號	TYPE 規格	D	Da	d	L	L1	Teeth 刀數	Insert 刀片規格	Screw 螺絲	Wrench 扳手
BTSPA1522000	SE - 5032 × 150	50	62	32	150	45	4	SEKT1204	SCR - SE5	T20
BTSPA1524000	SE - 5025 × 120	50	62	25	120	45	4			
BTSPA1526000	SE - 6332 × 150	63	74	32	150	45	5			
BTSPA1528000	SE - 6325 × 120	63	74	25	120	45	5			

* ISO Code
* 符合 ISO 規範

A037 SE445 Face Milling Cutter

SE445型高速平面銑刀

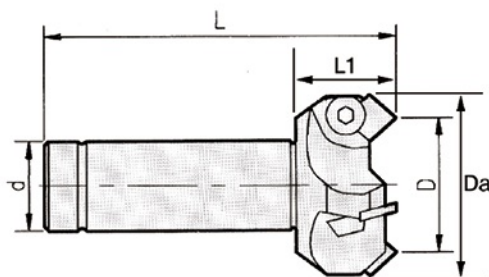

Code NO. 型號	TYPE 規格	D	Da	d	L	L1	Teeth 刀數	Insert 刀片規格	Screw 螺絲	Wrench 扳手
BTSPA1552000	SE445 - 5032 x 150	50	62	32	150	45	3	SEKN1203	SCR - W1 / 4L	WRN - M4L
BTSPA1554000	SE445 - 6332x 150	63	74	32	150	45	4			

* ISO Code
* 符合 ISO 規範

A038 TPR Shoulder Endmill

TPR直角端銑刀

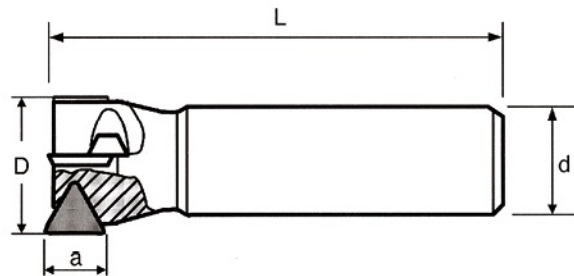

Code NO. 型號	TYPE 規格	D	d	L	a	Teeth 刃數	Insert 刀片規格	Screw 螺絲	Wrench 扳手
BTSPA1572000	TPR - 1616 × 110	16	16	110	11	1	TPMN1103	SCR-W3 / 16	WRN - M3L
BTSPA1576000	TPR - 2020 × 110	20	20	110	11	2			
BTSPA1580000	TPR - 2525 × 110	25	25	110	11	2	TPMN1603	SCR - W1 / 4	WRN - M4L
BTSPA1582000	TPR - 3020 × 130	30	20	130	16	2			
BTSPA1584000	TPR - 3025 × 130	30	25	130	16	2			
BTSPA1592000	TPR - 3520 × 130	35	20	130	16	2			
BTSPA1594000	TPR - 3525 × 130	35	25	130	16	2			
BTSPA1596000	TPR - 3532 × 150	35	32	150	16	2			
BTSPA1606000	TPR - 4020 × 130	40	20	130	16	3			
BTSPA1608000	TPR - 4025 × 130	40	25	130	16	3			
BTSPA1610000	TPR - 4032 × 150	40	32	150	16	3			
BTSPA1620000	TPR - 4520 × 130	45	20	130	16	3			
BTSPA1622000	TPR - 4525 × 130	45	25	130	16	3			
BTSPA1624000	TPR - 4532 × 150	45	32	150	16	3			
BTSPA1626000	TPR - 5020 × 130	50	20	130	16	3			
BTSPA1628000	TPR - 5025 × 130	50	25	130	16	3			
BTSPA1630000	TPR - 5032 × 150	50	32	150	16	3			
BTSPA1632000	TPR - 5032 × 200	50	32	200	16	3			
BTSPA1638000	TPR - 6332 × 150	63	32	150	16	4			

* ISO Code
* 符合 ISO 規範

A039 TPR22 Shoulder Endmill

TPR22直角端銑刀

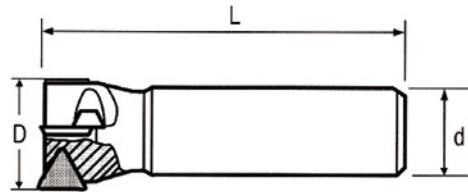

Code NO. 型號	TYPE 規格	D	d	L	Teeth 刃數	Insert 刀片規格	Screw 螺絲	Wrench 扳手
BTSPA1662000	TPR22 - 5032 × 150	50	32	150	3	TPMN2204	SCR-W5/16	WRN-M5L

*ISO Code
*符合 ISO 規範

A040 TPR R8-Shank Shoulder Endmill

TPR R8柄直角端銑刀

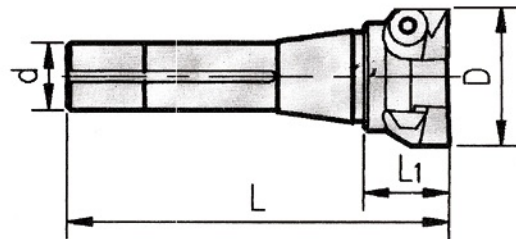

Code NO. 型號	TYPE 規格	D	L	L1	d	Teeth 刃數	Insert 刀片規格	Screw 螺絲	Wrench 扳手
BTSPA1702000	TPR - R8 × 1"	1"	145	45	24	2	TPMN1103	SCR-W3/16	WRN-M3L
BTSPA1704000	TPR - R8 × 1 - 1/4"	1 - 1/4"	145	45	24	2			
BTSPA1706000	TPR - R8 × 1 - 1/2"	1 - 1/2"	145	45	24	3			
BTSPA1710000	TPR - R8 × 2"	2"	145	45	24	3	TPMN1603	SCR-W1/4	WRN - M4L
BTSPA1712000	TPR - R8 × 2 - 1/2"	2 - 1/2"	145	45	24	4			
BTSPA1714000	TPR - R8 × 3"	3"	145	45	24	5			

*ISO Code
*符合 ISO 規範

A041 TPR Shoulder Face Milling Cutter

TPR直角平面銑刀（無墊片）

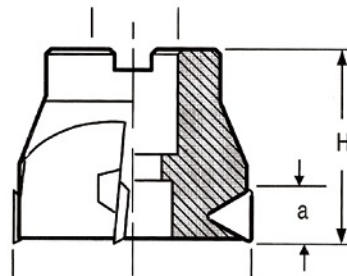

Code NO. 型號	TYPE 規格	D	d	H	H ₁	Teeth 刃數	Insert 刀片規格	Screw 螺絲	Wrench 扳手
BTSPA1732000	TPR - 50W / S	50	22	50	16	3	TPMN1603	SCR - W1/4	WRN - M4L
BTSPA1734000	TPR - 63W / S	63	25.4	50	16	4			

* ISO Code
* 符合 ISO 規範

A042 TPR Shoulder Face Milling Cutter

TPR直角平面銑刀

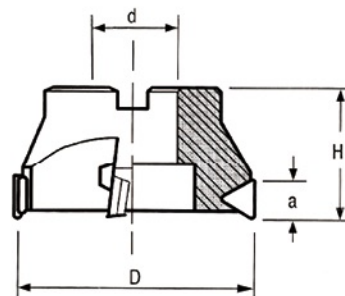

Code NO. 型號	TYPE 規格	D	d	H	H ₁	Teeth 刃數	Insert 刀片規格	Shim 墊片	Clamp Screw 壓板螺絲	Wrench 扳手	Screw 螺絲
BTSPA1752000	TPR - 63	63	25.4	50	22	3				WRN - M5L	
BTSPA1754000	TPR - 3	80	25.4	50	22	4					
BTSPA1756000	TPR - 4	100	31.75	55	22	5					
BTSPA1758000	TPR - 5	125	38.1	60	22	6					
BTSPA1760000	TPR - 6	160	50.8	60	22	7	TPMN2204	ST - T	SCR - W5 / 16	WRN - M5T	SCR - ST - T4
BTSPA1762000	TPR - 8	200	47.625	60	22	8					
BTSPA1764000	TPR - 10	250	47.625	60	22	9					
BTSPA1766000	TPR - 12	300	47.625	60	22	10					

* ISO Code
* 符合 ISO 規範

A043 SC Side Milling Cutter

SC千鳥型倒銑刀

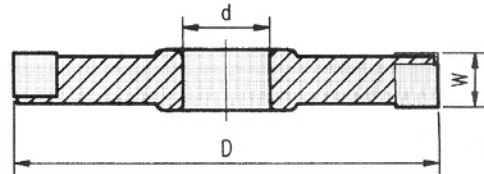

Code NO. 型號	TYPE 規格	D	d	W	Teeth 刃數	Insert 刀片規格	Clamp 壓板	Screw 螺絲	Wrench 扳手
BTSPA1792000	SC - 100 × 16	100	25.4	16	10	S P U N 120304	CL - S CL - SL	SCR - CL5 / 16	WRN - M4T
BTSPA1794000	SC - 125 × 16	125	25.4	16	14				
BTSPA1796000	SC - 150 × 16	150	25.4	16	16				
BTSPA1798000	SC - 200 × 16	200	31.75	16	20				

*ISO Code
*符合 ISO 規範

A044 SCT T-Type Side Milling Cutter

SCT T型側銑刀

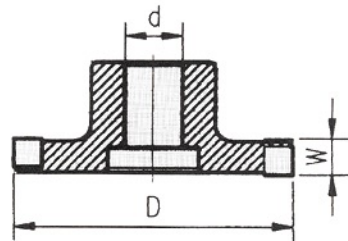

Code NO. 型號	TYPE 規格	D	d	W	Teeth 刃數	Insert 刀片規格	Clamp 壓板	Screw 螺絲	Wrench 扳手
BTSPA1822000	SCT - 100 × 16	100	1"	16	10	SPUN-1203	CL - S CL - SL	SCR - CL5 / 16	WRN - M4T
BTSPA1824000	SCT - 125 × 16	125	1 - 1 / 4"	16	14				
BTSPA1826000	SCT - 125 × 20	125	1 - 1 / 4"	20	14	SPUN-1504			
BTSPA1828000	SCT - 150 × 16	150	1 - 1 / 4"	16	16	SPUN-1203			
BTSPA1830000	SCT - 150 × 20	150	1 - 1 / 4"	20	16	SPUN-1504			
BTSPA1832000	SCT - 200 × 20	200	1 - 1 / 4"	20	20				
BTSPA1834000	SCT - 200 × 25	200	1 - 1 / 4"	25	20				

*ISO Code
*符合 ISO 規範

A045 FP 75° Face Milling Cutter

FP 75° 平面銑刀

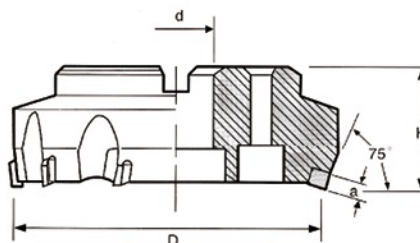

Code NO. 型號	TYPE 規格	D	d	H	a	Teeth 刃數	Insert 刀片規格	Clamp Screw 壓板螺絲	Clamp 壓板	Shim Screw 墊片螺絲	Shim 墊片	Wrench 扳手
BTSPA1850000	FP - 3	80	25.4	50	12	5	SPUN - 1203 SPKN - 1203 	SCR- CL5 / 16	CL-S	SCR-ST-S4	ST-S	WRN-M4T
BTSPA1854000	FP - 4	100	31.75	55	12	6						
BTSPA1856000	FP - 5	125	38.1	60	12	8						
BTSPA1858000	FP - 6	160	50.8	60	12	10						
BTSPA1860000	FP - 8	200	47.625	60	12	12						
BTSPA1862000	FP - 10	250	47.625	60	12	16						
BTSPA1864000	FP - 12	300	47.625	60	12	20						

* ISO Code
* 符合 ISO 規範

A046 A047 535,435 25° Face Milling Cutter

535,435 65° 平面銑刀

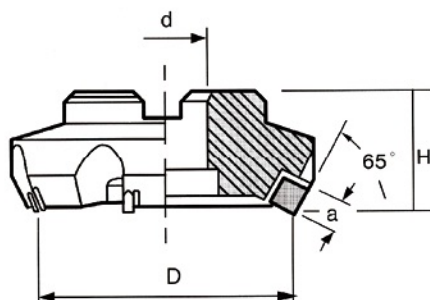

Code NO. 型號	TYPE 規格	D	d	H	a	Teeth 刃數	Code NO. 型號	TYPE 規格	D	d	H	a	Teeth 刃數
BTSPA1882000	535-3	80	25.4	50	15	5	BTSPA1912000	435-3	80	25.4	50	12	5
BTSPA1884000	535-4	100	31.75	55	15	5	BTSPA1914000	435-4	100	31.75	55	12	5
BTSPA1886000	535-5	125	38.1	60	15	6	BTSPA1916000	435-5	125	38.1	60	12	6
BTSPA1888000	535-6	160	50.8	60	15	8	BTSPA1918000	435-6	160	50.8	60	12	8
BTSPA1890000	535-8	200	47.625	60	15	10	BTSPA1920000	435-8	200	47.625	60	12	10
BTSPA1892000	535-10	250	47.625	60	15	12	BTSPA1922000	435-10	250	47.625	60	12	12
BTSPA1894000	535-12	300	47.625	60	15	14	BTSPA1924000	435-12	300	47.625	60	12	14

Clamp Screw 壓板螺絲	Clamp 壓板	Shim Screw 墊片螺絲	Shim 墊片	Wrench 扳手	Insert for CL5-S 刀片規格	Insert for CL4-S 刀片規格
SCR-CL5 / 16	CL5-S CL4-S	SCR-ST-S4	ST-S	WRN-M4T	SPKN1504 	SPKN1204

* ISO Code
* 符合 ISO 規範

A048 A049 545,445 45° Face Milling Cutter

545,445 45° 平面銑刀

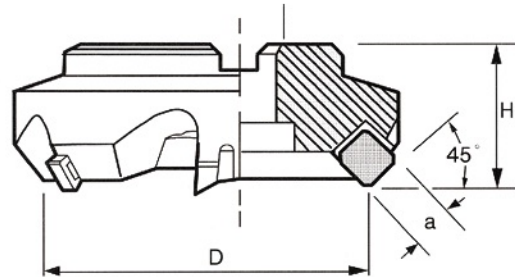

Code NO. 型號	TYPE 規格	D	d	H	a	Teeth 刃數	Code NO. 型號	TYPE 規格	D	d	H	a	Teeth 刃數
BTSPA1942000	545-3	80	25.4	50	15	5	BTSPA1972000	445-3	80	25.4	50	12	5
BTSPA1944000	545-4	100	31.75	55	15	5	BTSPA1974000	445-4	100	31.75	55	12	5
BTSPA1946000	545-5	125	38.1	60	15	6	BTSPA1976000	445-5	125	38.1	60	12	6
BTSPA1948000	545-6	160	50.8	60	15	8	BTSPA1978000	445-6	160	50.8	60	12	8
BTSPA1950000	545-8	200	47.625	60	15	10	BTSPA1980000	445-8	200	47.625	60	12	10
BTSPA1952000	545-10	250	47.625	60	15	12	BTSPA1982000	445-10	250	47.625	60	12	12
BTSPA1954000	54512	300	47.625	60	15	14	BTSPA1984000	445-12	300	47.625	60	12	14

Clamp Screw 壓板螺絲	Clamp 壓板	Shim Screw 墊片螺絲	Shim 墊片	Wrench 扳手	Insert for CL4-S 刀片規格	Insert for CL5-S 刀片規格
SCR -CL5 / 16	CL5-S CL4-S	SCR -ST - S4	ST - S	WRN -M4T	SEKN - 1504 15.875 4.76	SEKN - 1203 12.7 3.2

* ISO Code
* 符合 ISO 規範

A050 X-POWER Radius Milling Cutter

X-POWER 一體式圓刀刃銑刀

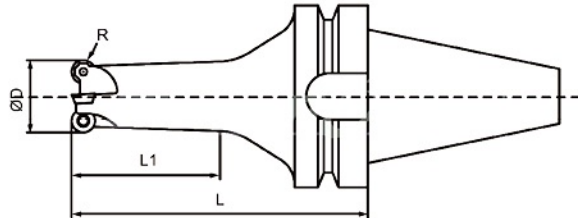

Code NO. 型號	TYPE 規格	ØD	L	L1	R	Teeth 刃數	Insert 刀片規格	Screw 螺絲	Wrench 扳手
BTSPA2002000	BT40 - XQP0820.90.3	20	90	40	4	3	QPMT0803	SCR - QP3	T8
BTSPA2004000	BT40 - XQP0825.100.4	25	100	50	4	4			
BTSPA2006000	BT40 - XQP0825.130.4	25	130	80	4	4			
BTSPA2008000	BT40 - XQP1025.100.3	25	100	50	5	3	QPMT10T3	SCR - QP3.5	T15
BTSPA2010000	BT40 - XQP1032.100.4	32	100	50	5	4			
BTSPA2012000	BT40 - XQP1032.130.4	32	130	80	5	4			

A051 C2334 Radius Endmill

C2334型R角端銑刀

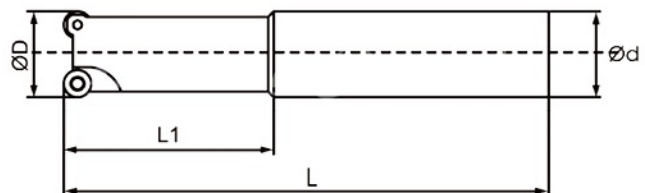

Code NO. 型號	TYPE 規格	ØD	Ød	L1	L	Teeth 刃數	Insert 刀片規格	Screw 螺絲	Wrench 扳手
BTSPA2032000	C2334 - 4R20 x 120	20	20	50	120	3	ROMX0803	SCR - R03	T8
BTSPA2034000	C2334 - 4R25 x 140	25	25	60	140	3			
BTSPA2036000	C2334 - 4R32 x 170	32	32	80	170	4			

* Walter inserts recommended
* 建議使用 Walter 刀片

A052 C2280 Octagon Face Milling Cutter

C2280 八角平面銑刀

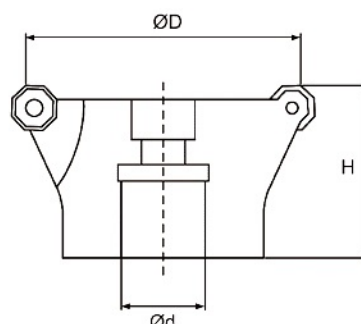

Code NO. 型號	TYPE 規格	ØD	Ød	H	Teeth 刀數	Insert 刀片規格	Screw 螺絲	Wrench 扳手
BTSPA2062000	C2280 - 50 x 22	50	22	40	4	ODMT0504 ODHT0504	SCR-OD3.5	T15
BTSPA2064000	C2280 - 63 x 25.4	63	25.4	40	6			
BTSPA2066000	C2280 - 63 x 22	63	22	40	6			
BTSPA2068000	C2280 - 80 x 25.4	80	25.4	50	7			
BTSPA2070000	C2280 - 80 x 27	80	27	50	7			
BTSPA2072000	C2280 - 100 x 31.75	100	31.75	50	8			
BTSPA2074000	C2280 - 100 x 32	100	32	50	8			
BTSPA2076000	C2280 - 125 x 38.1	125	38.1	63	10			
BTSPA2078000	C2280 - 125 x 40	125	40	63	10			
BTSPA2080000	C2280 - 160 x 50.8	160	50.8	63	12			
BTSPA2082000	C2280 - 160 x 40	160	40	63	12			
BTSPA2084000	C2280 - 200 x 47.625	200	47.625	63	14			
BTSPA2086000	C2280 - 200 x 60	200	60	63	14			

* Walter inserts recommended
* 建議使用 Walter 刀片

A053 SE13 High Speed Face Milling Cutter

SE13 高速平面殼型銑刀

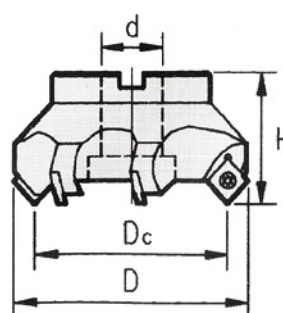

Code NO. 型號	TYPE 規格	ØD	Ød	H	Teeth 刀數	Insert 刀片規格	Screw 螺絲	Wrench 扳手
BTSPA2102000	SE13 - 63 x 25.4	63	25.4	50	5	SEMT13T3	SCR-SE4	T15
BTSPA2104000	SE13 - 63 x 22	63	22	50	5			
BTSPA2106000	SE13 - 80 x 25.4	80	25.4	55	6			
BTSPA2108000	SE13 - 80 x 27	80	27	55	6			
BTSPA2110000	SE13 - 100 x 31.75	100	31.75	55	6			
BTSPA2112000	SE13 - 100 x 32	100	32	55	6			
BTSPA2114000	SE13 - 125 x 38.1	125	38.1	60	8			
BTSPA2116000	SE13 - 125 x 40	125	40	60	8			
BTSPA2118000	SE13 - 150 x 50.8	150	50.8	60	10			
BTSPA2120000	SE13 - 150 x 40	150	40	60	10			
BTSPA2122000	SE13 - 200 x 47.62	200	47.625	60	12			
BTSPA2124000	SE13 - 200 x 60	200	60	60	12			

* Mitsubishi or Sandvik inserts recommended
* 建議使用 Mitsubishi 或 Sandvik 刀片

A054 RD Radius Corner Modular Endmill

RD型模組化R角銑刀

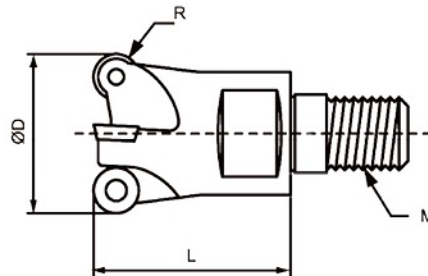

Code NO. 型號	TYPE 規格	ØD	L	M	R	Teeth 刀數	Insert 刀片規格	Screw 螺絲	Wrench 扳手
BTSPA2142000	RD05 - 1002M5	10	18	M5	2.5	2			
BTSPA2144000	RD05 - 1102M5	11	18	M5	2.5	2	RDHW0501	SCR-RD2.0	T6
BTSPA2146000	RD05 - 1203M6	12	19	M6	2.5	3			
BTSPA2148000	RD05 - 1303M6	13	19	M6	2.5	3			
BTSPA2150000	RD07 - 1603M8	16	23	M8	3.5	3	RDMT0702	SCR-RD2.5	T8
BTSPA2152000	RD07 - 1703M8	17	23	M8	3.5	3			
BTSPA2154000	RD07 - 2003M10	20	30	M10	3.5	3			
BTSPA2156000	RD07 - 2103M10	21	30	M10	3.5	3			
BTSPA2158000	RD07 - 2504M12	25	35	M12	3.5	4			
BTSPA2160000	RD07 - 2505M12	25	35	M12	3.5	5			
BTSPA2162000	RD07 - 2604M12	26	35	M12	3.5	4			
BTSPA2164000	RD07 - 3505M16	35	43	M16	3.5	5	RDMT1003	SCR-RD3.5	T15
BTSPA2166000	RD10 - 35C03M16	35	43	M16	5	3			
BTSPA2168000	RD10 - 35C04M16	35	43	M16	5	4			

* Safety inserts recommended
* 建議使用 Safety 刀片

A055 RT Lightning Modular Endmill

RT型模組化精面加工銑刀

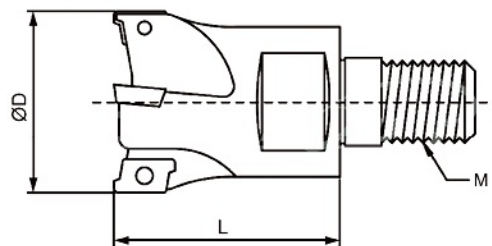

Code NO. 型號	TYPE 規格	ØD	L	M	Teeth 刀數	Insert 刀片規格	Screw 螺絲	Wrench 扳手
BTSPA2192000	RT07 - 1002M5	10	18	M5	2			
BTSPA2194000	RT07 - 1102M5	11	18	M5	2	RT0702	SCR-RT2.0	T6
BTSPA2196000	RT07 - 1202M6	12	19	M6	2			
BTSPA2198000	RT07 - 1302M6	13	19	M8	2			
BTSPA2200000	RT07 - 1603M8	16	25	M8	3	RT1003	SCR-RT2.5	T8
BTSPA2202000	RT07 - 1703M8	17	25	M8	3			
BTSPA2204000	RT10 - 1602M8	16	25	M8	2			
BTSPA2206000	RT10 - 1702M8	17	25	M8	2			
BTSPA2208000	RT10 - 2003M10	20	30	M10	3			
BTSPA2210000	RT10 - 2103M10	21	30	M10	3			
BTSPA2212000	RT10 - 2503M12	25	35	M12	3			
BTSPA2214000	RT10 - 2603M12	26	35	M12	3			
BTSPA2216000	RT10 - 3504M16	35	43	M16	4			

* Safety inserts recommended
* 建議使用 Safety 刀片

A056 EXT Modular Extension Bar

EXT型模組化延長桿

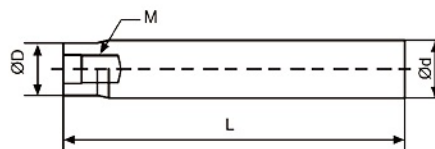

Code NO. 型號	TYPE 規格	ØD	Ød	M	L
BTSPA2242000	EXT - D10M5 - 100	9.5	10	M5	100
BTSPA2244000	EXT - D12M6 - 100	11.5	12	M6	100
BTSPA2246000	EXT - D16M8 - 130	14	16	M8	130
BTSPA2248000	EXT - D16M8 - 180	14	16	M8	180
BTSPA2250000	EXT - D20M10 - 130	18	20	M10	130
BTSPA2252000	EXT - D20M10 - 180	18	20	M10	180
BTSPA2254000	EXT - D25M12 - 200	23	25	M12	200
BTSPA2256000	EXT - D25M12 - 250	23	25	M12	250
BTSPA2258000	EXT - D25M12 - 300	23	25	M12	300
BTSPA2260000	EXT - D32M16 - 200	29	32	M16	200
BTSPA2262000	EXT - D32M16 - 250	29	32	M16	250
BTSPA2264000	EXT - D32M16 - 300	29	32	M16	300
BTSPA2266000	EXT - D32M16 - 350	29	32	M16	350

A057 RD Radius Corner Endmill

RD型R角端銑刀

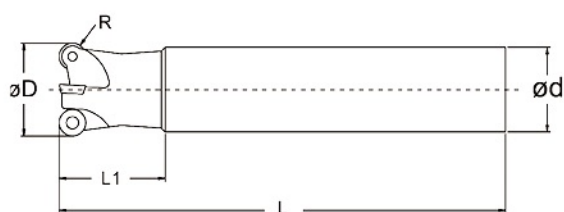

Code NO. 型號	TYPE 規格	ØD	Ød	L	L1	R	Teeth 刃數	Insert 刀片規格	Screw 螺絲	Wrench 扳手
BTSPA2296000	RD05 - 1203.12 × 100	12	12	100	30	2.5	3	RDWH0501	SCR-RD2.0	T6
BTSPA2298000	RD05 - 1303.12 × 100	13	12	100	30	2.5	3			
BTSPA2300000	RD07 - 1603.16 × 150	16	16	150	30	3.5	3			
BTSPA2302000	RD07 - 1703.16 × 150	17	16	150	30	3.5	3			
BTSPA2304000	RD07 - 1703.16 × 200	17	16	200	30	3.5	3	RDWT0702	SCR-RD2.5	T8
BTSPA2306000	RD07 - 2003.20 × 150	20	20	150	30	3.5	3			
BTSPA2308000	RD07 - 2103.20 × 150	21	20	150	30	3.5	3			
BTSPA2310000	RD07 - 2103.20 × 200	21	20	200	30	3.5	3			
BTSPA2312000	RD07 - 2504.25 × 150	25	25	150	30	3.5	4	RDWT1003	SCR-RD3.5	T15
BTSPA2314000	RD07 - 2604.25 × 150	26	25	150	30	3.5	4			
BTSPA2316000	RD07 - 2604.25 × 200	26	25	200	30	3.5	4			
BTSPA2318000	RD10 - 35C03.32 × 150	35	32	150	50	5	3			
BTSPA2320000	RD10 - 35C03.32 × 200	35	32	200	50	5	3	RDWT1003	SCR-RD3.5	T15
BTSPA2322000	RD10 - 35C03.32 × 250	35	32	250	50	5	3			
BTSPA2324000	RD10 - 35C03.32 × 300	35	32	300	50	5	3			
BTSPA2326000	RD10 - 35C04.32 × 150	35	32	150	50	5	4			
BTSPA2328000	RD10 - 35C04.32 × 200	35	32	200	50	5	4			

* Safety inserts recommended
* 建議使用 Safety 刀片

A058 RT Lightning Endmill

RT型精面加工端銑刀

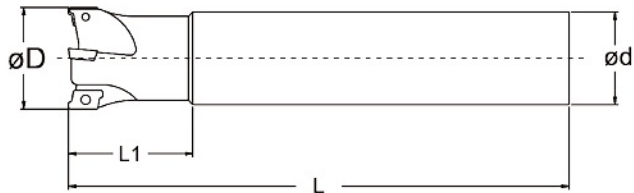

Code NO. 型號	TYPE 規格	$\varnothing D$	$\varnothing d$	L	L1	Teeth 刀數	Insert 刀片規格	Screw 螺絲	Wrench 扳手
BTSPA2352000	RT07 - 1002.10 × 120	10	10	120	30	2	RT0702	SCR-RT2.0	T6
BTSPA2354000	RT07 - 1102.10 × 120	11	10	120	30	2			
BTSPA2356000	RT07 - 1202.12 × 130	12	12	130	30	2			
BTSPA2358000	RT07 - 1302.12 × 130	13	12	130	30	2			
BTSPA2360000	RT07 - 1603.16 × 150	16	16	150	30	3			
BTSPA2362000	RT07 - 1703.16 × 150	17	16	150	30	3			
BTSPA2364000	RT10 - 1602.16 × 150	16	16	150	50	2	RT1003	SCR-RT2.5	T8
BTSPA2366000	RT10 - 1702.16 × 150	17	16	150	50	2			
BTSPA2368000	RT10 - 1702.16 × 200	17	16	200	50	2			
BTSPA2370000	RT10 - 2003.20 × 150	20	20	150	50	3			
BTSPA2372000	RT10 - 2103.20 × 150	21	20	150	50	3			
BTSPA2374000	RT10 - 2103.20 × 200	21	20	200	50	3			
BTSPA2376000	RT10 - 2103.20 × 250	21	20	250	50	3			
BTSPA2378000	RT10 - 2503.25 × 200	25	25	200	50	3			
BTSPA2380000	RT10 - 2603.25 × 150	26	25	150	50	3			
BTSPA2382000	RT10 - 2603.25 × 200	26	25	200	50	3			
BTSPA2384000	RT10 - 2603.25 × 250	26	25	250	50	3			
BTSPA2386000	RT10 - 2603.25 × 300	26	25	300	50	3			
BTSPA2388000	RT10 - 3504.32 × 150	35	32	150	50	4			
BTSPA2390000	RT10 - 3504.32 × 200	35	32	200	50	4			
BTSPA2392000	RT10 - 3504.32 × 250	35	32	250	50	4			
BTSPA2394000	RT10 - 3504.32 × 300	35	32	300	50	4			

* Safety inserts recommended
* 建議使用 Safety 刀片

A059 APX 12 High-Speed Rough Endmill

APX 12型高速端銑刀



Code NO. 型號	TYPE 規格	øD	ød	L	L1	Teeth 刃數	Insert 刀片規格	Screw 螺絲	Wrench 扳手
BTSPA2412000	APX12 - 1616 × 120	16	16	120	24	2	AOMT 1236	SCR-APX2.5	T8
BTSPA2414000	APX12 - 1616 × 150	16	16	150	24	2			
BTSPA2416000	APX12 - 1716 × 150	17	16	150	24	2			
BTSPA2418000	APX12 - 2020 × 150	20	20	150	29	3			
BTSPA2420000	APX12 - 2120 × 150	21	20	150	29	3			
BTSPA2422000	APX12 - 2120 × 200	21	20	200	29	3			
BTSPA2424000	APX12 - 2525 × 150	25	25	150	34	4			
BTSPA2426000	APX12 - 2525 × 200	25	25	200	34	4			
BTSPA2428000	APX12 - 2625 × 200	26	25	200	34	4			

* Mitsubishi inserts recommended
* 建議使用 Mitsubishi 刀片

A060 C4033 Powerful Face Milling Cutter

C4033強力平面銑刀

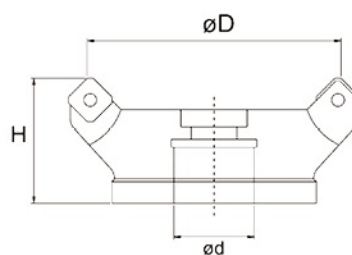

Code NO. 型號	TYPE 規格	øD	ød	H	Teeth 刃數	Insert 刀片規格	Screw 螺絲	Wrench 扳手
BTSPA2452000	C4033 - 50 × 22	50	22	40	4	SNMX 1205 SNGX 1205	SCR-SN4	T15
BTSPA2454000	C4033 - 63 × 25.4	63	25.4	40	6			
BTSPA2456000	C4033 - 63 × 22	63	22	40	6			
BTSPA2458000	C4033 - 80 × 25.4	80	25.4	50	6			
BTSPA2460000	C4033 - 80 × 27	80	27	50	6			
BTSPA2462000	C4033 - 100 × 31.75	100	31.75	50	8			
BTSPA2464000	C4033 - 100 × 32	100	32	50	8			
BTSPA2466000	C4033 - 125 × 38.1	125	38.1	63	10			
BTSPA2468000	C4033 - 125 × 40	125	40	63	10			
BTSPA2470000	C4033 - 160 × 50.8	160	50.8	63	12			
BTSPA2472000	C4033 - 160 × 40	160	40	63	12			
BTSPA2474000	C4033 - 200 × 47.625	200	47.625	63	18			
BTSPA2476000	C4033 - 200 × 60	200	60	63	18			

* Walter inserts recommended
* 建議使用 Walter 刀片

A062 EXD Power Super Drill 3D

EXD型快速鑽(3倍)

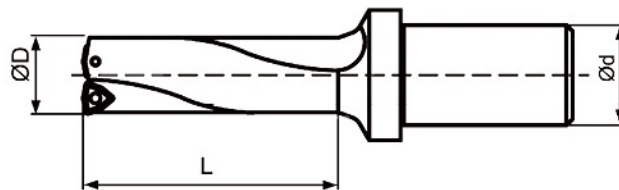

Code NO. 型號	TYPE 規格	ØD	Ød	L	Insert 刀片規格	Screw 螺絲	Wrench 扳手		
BTSPA2562000	EXD - 14 × 3 - 25	14	25	42	WCMX0302	SCR-EXD2.5	T8		
BTSPA2564000	EXD - 15 × 3 - 25	15	25	45					
BTSPA2566000	EXD - 16 × 3 - 25	16	25	48					
BTSPA2568000	EXD - 17 × 3 - 25	17	25	51					
BTSPA2570000	EXD - 18 × 3 - 25	18	25	54					
BTSPA2572000	EXD - 19 × 3 - 25	19	25	57					
BTSPA2574000	EXD - 20 × 3 - 25	20	25	60	WCMX0402	SCR-EXD2.5			
BTSPA2576000	EXD - 21 × 3 - 32	21	32	63					
BTSPA2578000	EXD - 22 × 3 - 32	22	32	66					
BTSPA2580000	EXD - 23 × 3 - 32	23	32	69					
BTSPA2582000	EXD - 24 × 3 - 32	24	32	72					
BTSPA2584000	EXD - 25 × 3 - 32	25	32	75					
BTSPA2586000	EXD - 26 × 3 - 32	26	32	78	WCMX0503	SCR-EXD3			
BTSPA2588000	EXD - 27 × 3 - 32	27	32	81					
BTSPA2590000	EXD - 28 × 3 - 32	28	32	84					
BTSPA2592000	EXD - 29 × 3 - 32	29	32	87					
BTSPA2594000	EXD - 30 × 3 - 32	30	32	90					
BTSPA2596000	EXD - 31 × 3 - 32	31	32	93			WCMX06T3	SCR-EXD3.5	T15
BTSPA2598000	EXD - 32 × 3 - 32	32	32	96					
BTSPA2600000	EXD - 33 × 3 - 32	33	32	99					
BTSPA2602000	EXD - 34 × 3 - 32	34	32	102					
BTSPA2604000	EXD - 35 × 3 - 32	35	32	105					
BTSPA2606000	EXD - 36 × 3 - 32	36	32	108					
BTSPA2608000	EXD - 37 × 3 - 32	37	32	111					
BTSPA2610000	EXD - 38 × 3 - 32	38	32	114					
BTSPA2612000	EXD - 39 × 3 - 32	39	32	117	WCMX0804	SCR-EXD4			
BTSPA2614000	EXD - 40 × 3 - 40	40	40	120					
BTSPA2616000	EXD - 41 × 3 - 40	41	40	123					
BTSPA2618000	EXD - 42 × 3 - 40	42	40	126					
BTSPA2620000	EXD - 43 × 3 - 40	43	40	129					
BTSPA2622000	EXD - 44 × 3 - 40	44	40	132					
BTSPA2624000	EXD - 45 × 3 - 40	45	40	135	WCMX06T3	SCR-EXD3.5			
BTSPA2626000	EXD - 46 × 3 - 40	46	40	138					
BTSPA2628000	EXD - 47 × 3 - 40	47	40	141					
BTSPA2630000	EXD - 48 × 3 - 40	48	40	144					
BTSPA2632000	EXD - 49 × 3 - 40	49	40	147					
BTSPA2634000	EXD - 50 × 3 - 40	50	40	150					
BTSPA2636000	EXD - 51 × 3 - 40	51	40	153					
BTSPA2638000	EXD - 52 × 3 - 40	52	40	156					
BTSPA2640000	EXD - 53 × 3 - 40	53	40	159					
BTSPA2642000	EXD - 54 × 3 - 40	54	40	162					
BTSPA2644000	EXD - 55 × 3 - 40	55	40	165					
BTSPA2646000	EXD - 56 × 3 - 40	56	40	168					
BTSPA2648000	EXD - 57 × 3 - 40	57	40	171					
BTSPA2650000	EXD - 58 × 3 - 40	58	40	174					
BTSPA2652000	EXD - 59 × 3 - 40	59	40	177					
BTSPA2654000	EXD - 60 × 3 - 40	60	40	180					

* ISO Code
* 符合 ISO 規範

A063 EXD Power Super Drill 4D

EXD型快速鑽(4倍)

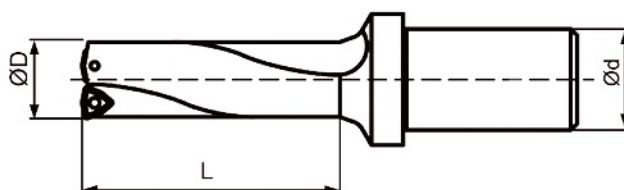

Code NO. 型號	TYPE 規格	ØD	Ød	L	Insert 刀片規格	Screw 螺絲	Wrench 扳手
BTSPA2672000	EXD - 15 × 4 - 25	15	25	60	WCMX0302	SCR-EXD2.5	T8
BTSPA2674000	EXD - 16 × 4 - 25	16	25	64			
BTSPA2676000	EXD - 17 × 4 - 25	17	25	68			
BTSPA2678000	EXD - 18 × 4 - 25	18	25	72			
BTSPA2680000	EXD - 19 × 4 - 25	19	25	76	WCMX0402	SCR-EXD2.5	T8
BTSPA2682000	EXD - 20 × 4 - 25	20	25	80			
BTSPA2684000	EXD - 21 × 4 - 32	21	32	84			
BTSPA2686000	EXD - 22 × 4 - 32	22	32	88			
BTSPA2688000	EXD - 23 × 4 - 32	23	32	92	WCMX0503	SCR-EXD3	T8
BTSPA2690000	EXD - 24 × 4 - 32	24	32	96			
BTSPA2692000	EXD - 25 × 4 - 32	25	32	100			
BTSPA2694000	EXD - 26 × 4 - 32	26	32	104			
BTSPA2696000	EXD - 27 × 4 - 32	27	32	108	WCMX06T3	SCR-EXD3.5	T15
BTSPA2698000	EXD - 28 × 4 - 32	28	32	112			
BTSPA2700000	EXD - 29 × 4 - 32	29	32	116			
BTSPA2702000	EXD - 30 × 4 - 32	30	32	120			
BTSPA2704000	EXD - 31 × 4 - 32	31	32	124	WCMX06T3	SCR-EXD3.5	T15
BTSPA2706000	EXD - 32 × 4 - 32	32	32	128			
BTSPA2708000	EXD - 33 × 4 - 32	33	32	132			
BTSPA2710000	EXD - 34 × 4 - 32	34	32	136			
BTSPA2712000	EXD - 35 × 4 - 32	35	32	140	WCMX0804	SCR-EXD4	T15
BTSPA2714000	EXD - 36 × 4 - 32	36	32	144			
BTSPA2716000	EXD - 37 × 4 - 32	37	32	148			
BTSPA2718000	EXD - 38 × 4 - 32	38	32	152			
BTSPA2720000	EXD - 39 × 4 - 32	39	32	156	WCMX06T3	SCR-EXD3.5	T15
BTSPA2722000	EXD - 40 × 4 - 40	40	40	160			
BTSPA2724000	EXD - 41 × 4 - 40	41	40	164			
BTSPA2726000	EXD - 42 × 4 - 40	42	40	168			
BTSPA2728000	EXD - 43 × 4 - 40	43	40	172	WCMX06T3	SCR-EXD3.5	T15
BTSPA2730000	EXD - 44 × 4 - 40	44	40	176			
BTSPA2732000	EXD - 45 × 4 - 40	45	40	180			
BTSPA2734000	EXD - 46 × 4 - 40	46	40	184			
BTSPA2736000	EXD - 47 × 4 - 40	47	40	188	WCMX06T3	SCR-EXD3.5	T15
BTSPA2738000	EXD - 48 × 4 - 40	48	40	192			
BTSPA2740000	EXD - 49 × 4 - 40	49	40	196			
BTSPA2742000	EXD - 50 × 4 - 40	50	40	200			
BTSPA2744000	EXD - 51 × 4 - 40	51	40	204	WCMX06T3	SCR-EXD3.5	T15
BTSPA2746000	EXD - 52 × 4 - 40	52	40	208			
BTSPA2748000	EXD - 53 × 4 - 40	53	40	212			
BTSPA2750000	EXD - 54 × 4 - 40	54	40	216			
BTSPA2752000	EXD - 55 × 4 - 40	55	40	220	WCMX06T3	SCR-EXD3.5	T15
BTSPA2754000	EXD - 56 × 4 - 40	56	40	224			
BTSPA2756000	EXD - 57 × 4 - 40	57	40	228			
BTSPA2758000	EXD - 58 × 4 - 40	58	40	232			
BTSPA2760000	EXD - 59 × 4 - 40	59	40	236	WCMX06T3	SCR-EXD3.5	T15
BTSPA2762000	EXD - 60 × 4 - 40	60	40	240			

* ISO Code
* 符合 ISO 規範

A064 WEX High-Speed Rough Endmill

WEX型高速端銑刀

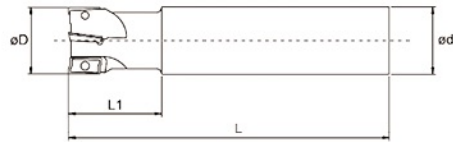

Code NO. 型號	TYPE 規格	øD	ød	L	L1	Teeth 刃數	Insert 刀片規格	Screw 螺絲	Wrench 扳手
BTSPA2782000	WEX12 - 1616 × 100	16	16	100	25	2	AXMT1235	SCR-WEX3	T8
BTSPA2784000	WEX12 - 1816 × 100	18	16	100	25	2			
BTSPA2786000	WEX12 - 2020 × 110	20	20	110	30	3			
BTSPA2788000	WEX12 - 2020 × 150	20	20	150	40	3			
BTSPA2790000	WEX12 - 2220 × 110	22	20	110	30	3			
BTSPA2792000	WEX12 - 2525 × 120	25	25	120	35	4			
BTSPA2794000	WEX12 - 2525 × 170	25	25	170	50	4			
BTSPA2796000	WEX12 - 2825 × 120	28	25	120	35	4			
BTSPA2798000	WEX12 - 3232 × 130	32	32	130	40	5			
BTSPA2800000	WEX12 - 3232 × 180	32	32	180	60	5			
BTSPA2802000	WEX17 - 2525 × 120	25	25	120	35	2	AXMT1705	SCR-WEX4	T15
BTSPA2804000	WEX17 - 2625 × 120	26	25	120	35	2			
BTSPA2806000	WEX17 - 2825 × 120	28	25	120	35	2			
BTSPA2808000	WEX17 - 3232 × 130	32	32	130	40	3			
BTSPA2810000	WEX17 - 3232 × 180	32	32	180	60	3			
BTSPA2812000	WEX17 - 3532 × 130	35	32	130	40	3			
BTSPA2814000	WEX17 - 4032 × 170	40	32	170	50	4			

*Nachi or Sumitomo inserts recommended
*建議使用Nachi 或 Sumitomo 銑刀片

A065 WEX High-Speed Rough Face Milling Cutter

WEX型高速平面銑刀

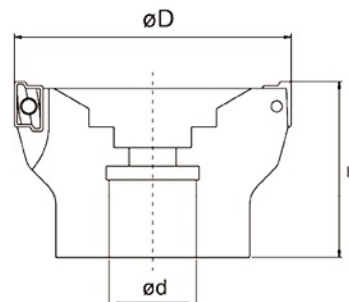

Code NO. 型號	TYPE 規格	øD	ød	H	Teeth 刃數	Insert 刀片規格	Screw 螺絲	Wrench 扳手
BTSPA2832000	WEX12 - 50 × 22	50	22	40	7	AXMT1235	SCR-WEX3	T8
BTSPA2834000	WEX12 - 63 × 22	63	22	40	8			
BTSPA2836000	WEX17 - 50 × 22	50	22	40	5			
BTSPA2838000	WEX17 - 63 × 22	63	22	40	6	AXMT1705	SCR-WEX4	T15
BTSPA2840000	WEX17 - 80 × 25.4	80	25.4	50	7			
BTSPA2842000	WEX17 - 100 × 31.75	100	31.75	63	8			
BTSPA2844000	WEX17 - 125 × 38.1	125	38.1	63	9			

*Nachi or Sumitomo inserts recommended
*建議使用Nachi 或 Sumitomo 銑刀片

Screw

螺絲



Code NO. 型號	TYPE 規格
BTSDA0167000	SCR-APX2.5
BTSDA0168000	SCR-AR10
BTSDA0169000	SCR-AR12.5
BTSDA0170000	SCR-AR8
BTSDA0171000	SCR-CAP2.5
BTSDA0172000	SCR-CAP4
BTSDA0173000	SCR-CBP3.5
BTSDA0174000	SCR-CBP5
BTSDA0175000	SCR-CEX3.5
BTSDA0176000	SCR-CEX4
BTSDA0177000	SCR-CJU2.5
BTSDA0178000	SCR-CJU3.5
BTSDA0179000	SCR-CJU4
BTSDA0180000	SCR-CJU5
BTSDA0181000	SCRCL5/16
BTSDA0182000	SCR-CR10
BTSDA0183000	SCR-CR12.5
BTSDA0184000	SCR-CR4
BTSDA0185000	SCR-CR5
BTSDA0186000	SCR-CR6
BTSDA0187000	SCR-CR8
BTSDA0188000	SCR-CRC4
BTSDA0189000	SCR-CRC5
BTSDA0190000	SCR-CRP3
BTSDA0191000	SCR-CRP4
BTSDA0192000	SCR-CRS3

Code NO. 型號	TYPE 規格
BTSDA0193000	SCR-CRS4
BTSDA0194000	SCR-CRS5
BTSDA0195000	SCR-CRT4
BTSDA0196000	SCR-CSJ2.5
BTSDA0197000	SCR-CSJ3
BTSDA0198000	SCR-CSJ4
BTSDA0199000	SCR-EHU2.5
BTSDA0200000	SCR-EHU4
BTSDA0201000	SCR-ESR3.5
BTSDA0202000	SCR-ESR4
BTSDA0203000	SCR-ESR5
BTSDA0204000	SCR-EXD2.5
BTSDA0205000	SCR-EXD3
BTSDA0206000	SCR-EXD3.5
BTSDA0207000	SCR-EXD4
BTSDA0208000	SCR-IMP3
BTSDA0209000	SCR-IMP4
BTSDA0210000	SCR-OD2.5
BTSDA0211000	SCR-QP3
BTSDA0212000	SCR-QP3.5
BTSDA0213000	SCR-RD2.0
BTSDA0214000	SCR-RD2.5
BTSDA0215000	SCR-RD3.5
BTSDA0216000	SCR-RGH2.5
BTSDA0217000	SCR-RGH4
BTSDA0218000	SCR-RGH5

Code NO. 型號	TYPE 規格
BTSDA0219000	SCR-RGZ4
BTSDA0220000	SCR-RGZ5
BTSDA0221000	SCR-R03
BTSDA0222000	SCR-RT2.0
BTSDA0223000	SCR-RT2.5
BTSDA0224000	SCR-SE4
BTSDA0225000	SCR-SE5
BTSDA0226000	SCR-SFM5
BTSDA0227000	SCR-SN3.5
BTSDA0228000	SCR-ST-S4
BTSDA0229000	SCR-ST-T4
BTSDA0230000	SCR-TB2.5
BTSDA0231000	SCR-TB3.5
BTSDA0232000	SCR-TCM4
BTSDA0233000	SCR-TS2.5
BTSDA0234000	SCR-TS4
BTSDA0235000	SCR-TS5
BTSDA0236000	SCR-W1 / 4
BTSDA0237000	SCR-W1 / 4L
BTSDA0238000	SCR-W3 / 16
BTSDA0239000	SCR-W3 / 16S
BTSDA0240000	SCR-W5 / 16
BTSDA0241000	SCR-WEX3
BTSDA0242000	SCR-WEX4
BTSDA0243000	SCR-XEM2.5
BTSDA0244000	SCR-XEM4

Wrench

扳手



Code NO. 型號	TYPE 規格
BTSTD0001000	T6
BTSTD0003000	T8
BTSTD0004000	T10
BTSTD0005000	T15
BTSTD0006000	T20
BTSTD0007000	T30
BTSTD0008000	WRN-M3L
BTSTD0009000	WRN-M4L
BTSTD0010000	WRN-M4T
BTSTD0011000	WRN-M5L
BTSTD0012000	WRE-M5L

Milling Cutter Inserts

Metric Series ISO 1832-1991

S E A N 12 03 A F T N - M16

1 2 3 4 5 6 7 8 9 10

1 Shape

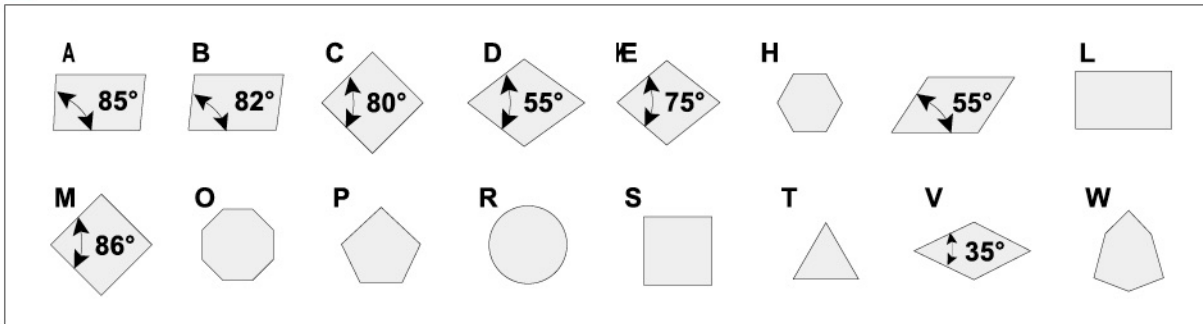

2 Clearance angle

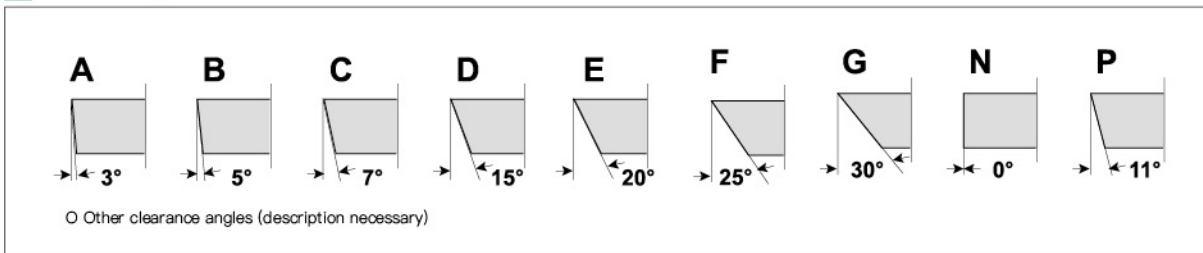

3 MC Mechanical Power Vise

Tol class	Tolerance ± mm			Ford, dimension mm					
	m	s	d	6.53	9.525	12.7	15.875	19.05	25.4
A	0.005	0.025	0.025	•	•	•	•	•	•
E	0.025	0.025	0.025	•	•	•	•	•	•
F	0.005	0.025	0.013	•	•	•	•	•	•
G	0.025	0.130	0.025	•	•	•	•	•	•
H	0.013	0.025	0.013	•	•	•	•	•	•
J	0.005	0.025	0.050	•	•				
	0.005	0.025	0.080			•			
	0.005	0.025	0.100				•	•	
K	0.013	0.025	0.050	•	•				
	0.013	0.025	0.080			•			
	0.013	0.025	0.100				•	•	
M	0.013	0.025	0.130						•
	0.080	0.130	0.050	•	•				
	0.130	0.130	0.080			•			
U	0.150	0.130	0.100				•	•	
	0.180	0.130	0.130						•
	0.13	0.130	0.080	•	•				
U	0.200	0.130	0.130			•			
	0.270	0.130	0.180				•	•	
	0.380	0.130	0.250						•

4 Type of Insert

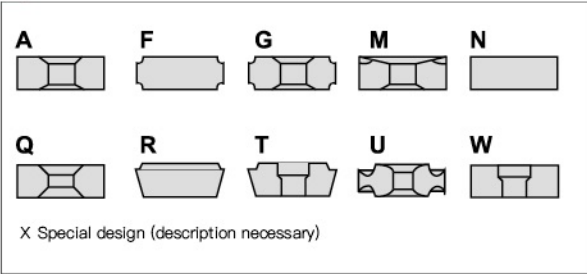

5 Cutting edge length

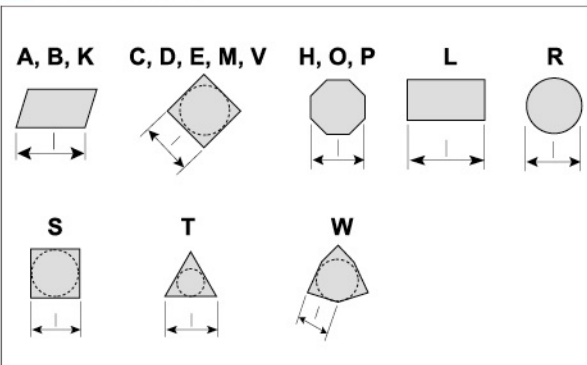

Comparison
Cutting edge length/I.C. (d)

IC (d)	shape					
	C	D	R,S	T	V	W
5.56						03
6.35	06	07	06	11		04
12.70	09	11	09	16	16	06
15.88	16	19	15	22		08
19.05	19	23	19	33		
25.40	25	31	25	44		

IC = Theoretical diameter of inscribed circle

6 Thickness

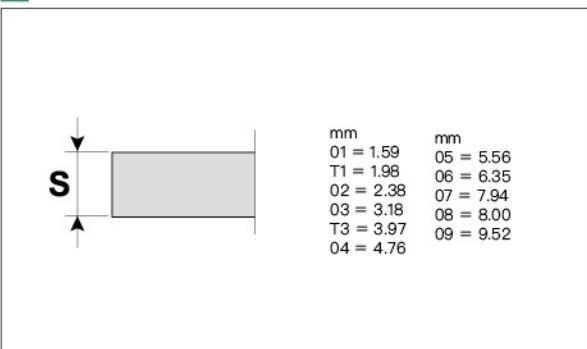

7 Insert with Wiper Edge/Radius

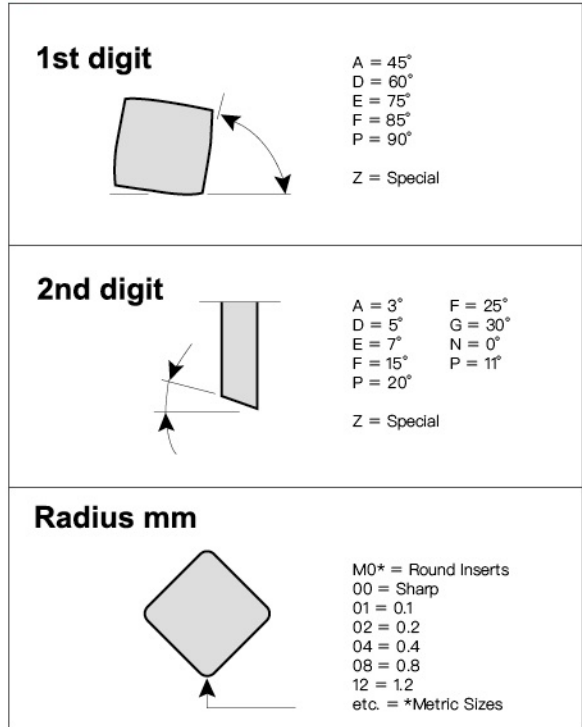

8 Cutting Edge Condition

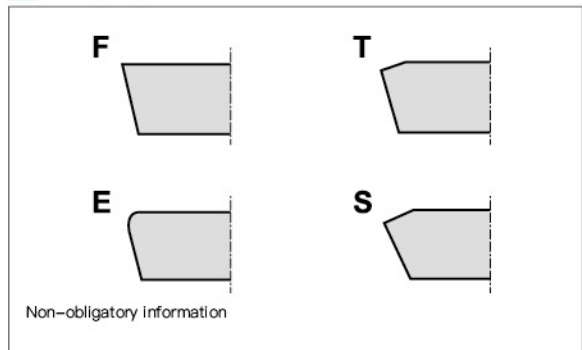

9 Direction of Cutting

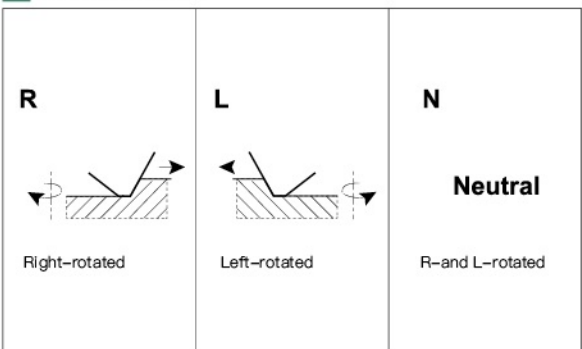

Slotting & Grooving Empire

切槽王國

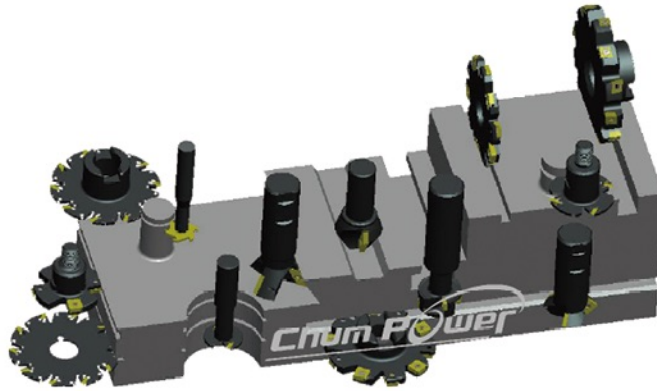

TS T-slot milling cutters

T型銑刀





組合示意圖
Schematic Diagram

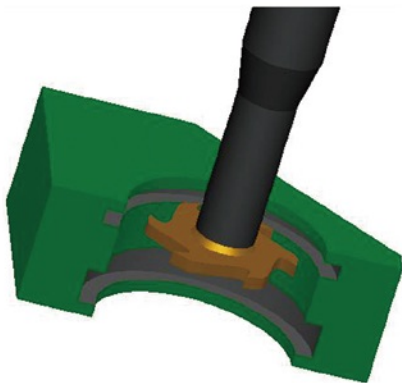

模擬圖
Analog Picture

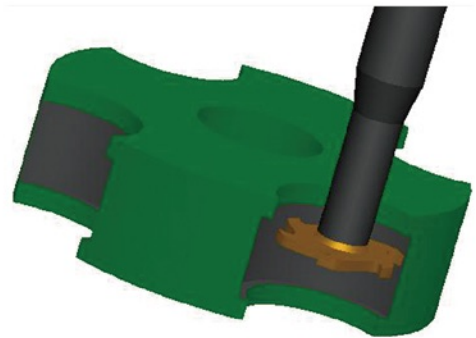

模擬圖
Analog Picture